

International Energy Agency

## Deep Energy Retrofit Pilot Projects

**Annex 61, Subtask C**

October 2017





International Energy Agency

## Deep Energy Retrofit Pilot Projects

---

### Annex 61, Subtask C

October 2017

**Authors**

Cyrus Nasser, U.S. Department of Energy, Federal Energy Management Program, USA.

Ruediger Lohse, KEA (KEA Klimaschutz–und Energieagentur), Germany

Lawrence Markel, CSRA, Inc., USA.

Ove Moerck, Cenergia Energy Consultants, Denmark

Kinga Porst Hydras, U.S. General Services Administration

Martina Riel, KEA (Klimaschutz und Energieagentur), Germany

Jay Tulley, U.S. Army Garrison, Presidio of Monterey, USA.

Brian Clark, U.S. Army ERDC, USA.

Targo Kalamees, Technical University of Tallinn, Estonia

**Contributors:**

Julia Blackburn, CSRA, Inc., USA.

Kevin Bunker, U.S. General Services Administration, USA.

Alexander Zhivov, US Army ERDC, USA.

© Copyright IEA EBC Annex 61 Operating Agents 2017

All property rights, including copyright, are vested in IEA EBC Annex 61 Operating Agents 2017, on behalf of the Contracting Parties of the International Energy Agency Implementing Agreement for a Programme of Research and Development on Energy in Buildings and Communities.

In particular, no part of this publication may be reproduced, stored in a retrieval system or transmitted in any form or by any means, electronic, mechanical, photocopying, recording or otherwise, without the prior written permission of IEA EBC Annex 61 Operating Agents 2017.

Published by New Buildings Institute (NBI)

Disclaimer Notice: This publication has been compiled with reasonable skill and care. However, neither IEA EBC Annex 61 Operating Agents 2017 nor the Contracting Parties of the International Energy Agency Implementing Agreement for a Programme of Research and Development on Energy in Buildings and Communities make any representation as to the adequacy or accuracy of the information contained herein, or as to its suitability for any particular application, and accept no responsibility or liability arising out of the use of this publication. The information contained herein does not supersede the requirements given in any national codes, regulations or standards, and should not be regarded as a substitute for the need to obtain specific professional advice for any particular application.

ISBN 978-3-9819330-4-8

Participating countries in EBC:

Australia, Austria, Belgium, Canada, P.R. China, Czech Republic, Denmark, France, Germany, Ireland, Italy, Japan, Republic of Korea, the Netherlands, New Zealand, Norway, Portugal, Singapore, Spain, Sweden, Switzerland, United Kingdom and the United States of America.

Additional copies of this report may be obtained from:

EBC Bookshop  
C/o AECOM Ltd  
The Colmore Building  
Colmore Circus Queensway  
Birmingham B4 6AT  
United Kingdom  
Web: [www.IEA EBC.org](http://www.IEA EBC.org)  
Email: [essu@IEA EBC.org](mailto:essu@IEA EBC.org)

## Preface

### THE INTERNATIONAL ENERGY AGENCY

The International Energy Agency (IEA) was established in 1974 within the framework of the Organization for Economic Cooperation and Development (OECD) to implement an international energy programme. A basic aim of the IEA is to foster international cooperation among the 29 IEA participating countries and to increase energy security through energy research, development, and demonstration in the fields of technologies for energy efficiency and renewable energy sources.

### THE IEA ENERGY IN BUILDINGS AND COMMUNITIES PROGRAMME

The IEA coordinates international energy research and development (R&D) activities through a comprehensive portfolio of Technology Collaboration Programmes. The mission of the IEA Energy in Buildings and Communities (IEA EBC) Programme is to develop and facilitate the integration of technologies and processes for energy efficiency and conservation into healthy, low emission, and sustainable buildings and communities through innovation and research. (Until March 2013, the IEA EBC Programme was known as the IEA Energy in Buildings and Community Systems Programme, ECBCS.)

The R&D strategies of the IEA EBC Programme are derived from research drivers, national programmes within IEA countries, and the IEA Future Buildings Forum Think Tank Workshops. These R&D strategies aim to exploit technological opportunities to save energy in the buildings sector, and to remove technical obstacles to market penetration of new energy efficient technologies. The R&D strategies apply to residential, commercial, office buildings and community systems, and will impact the building industry in five areas of focus for R&D activities:

- Integrated planning and building design
- Building energy systems
- Building envelope
- Community scale methods
- Real building energy use.

### THE EXECUTIVE COMMITTEE

Overall control of the IEA EBC Programme is maintained by an Executive Committee, which not only monitors existing projects, but also identifies new strategic areas in which collaborative efforts may be beneficial. As the Programme is based on a contract with the IEA, the projects are legally established as Annexes to the IEA EBC Implementing Agreement. At the present time, the following projects have been initiated by the IEA EBC Executive Committee, with completed projects identified by (\*):

- Annex 1: Load Energy Determination of Buildings (\*)
- Annex 2: Ekistics and Advanced Community Energy Systems (\*)
- Annex 3: Energy Conservation in Residential Buildings (\*)
- Annex 4: Glasgow Commercial Building Monitoring (\*)
- Annex 5: Air Infiltration and Ventilation Centre
- Annex 6: Energy Systems and Design of Communities (\*)
- Annex 7: Local Government Energy Planning (\*)
- Annex 8: Inhabitants Behaviour with Regard to Ventilation (\*)
- Annex 9: Minimum Ventilation Rates (\*)
- Annex 10: Building HVAC System Simulation (\*)
- Annex 11: Energy Auditing (\*)
- Annex 12: Windows and Fenestration (\*)
- Annex 13: Energy Management in Hospitals (\*)
- Annex 14: Condensation and Energy (\*)
- Annex 15: Energy Efficiency in Schools (\*)
- Annex 16: BEMS 1- User Interfaces and System Integration (\*)
- Annex 17: BEMS 2- Evaluation and Emulation Techniques (\*)
- Annex 18: Demand Controlled Ventilation Systems (\*)
- Annex 19: Low Slope Roof Systems (\*)
- Annex 20: Air Flow Patterns within Buildings (\*)
- Annex 21: Thermal Modelling (\*)
- Annex 22: Energy Efficient Communities (\*)
- Annex 23: Multi Zone Air Flow Modelling (COMIS) (\*)

- Annex 24: Heat, Air and Moisture Transfer in Envelopes (\*)
- Annex 25: Real time HVAC Simulation (\*)
- Annex 26: Energy Efficient Ventilation of Large Enclosures (\*)
- Annex 27: Evaluation and Demonstration of Domestic Ventilation Systems (\*)
- Annex 28: Low Energy Cooling Systems (\*)
- Annex 29: Daylight in Buildings (\*)
- Annex 30: Bringing Simulation to Application (\*)
- Annex 31: Energy-Related Environmental Impact of Buildings (\*)
- Annex 32: Integral Building Envelope Performance Assessment (\*)
- Annex 33: Advanced Local Energy Planning (\*)
- Annex 34: Computer-Aided Evaluation of HVAC System Performance (\*)
- Annex 35: Design of Energy Efficient Hybrid Ventilation (HYBVENT) (\*)
- Annex 36: Retrofitting of Educational Buildings (\*)
- Annex 37: Low Exergy Systems for Heating and Cooling of Buildings (LowEx) (\*)
- Annex 38: Solar Sustainable Housing (\*)
- Annex 39: High Performance Insulation Systems (\*)
- Annex 40: Building Commissioning to Improve Energy Performance (\*)
- Annex 41: Whole Building Heat, Air and Moisture Response (MOIST-ENG) (\*)
- Annex 42: The Simulation of Building-Integrated Fuel Cell and Other Cogeneration Systems (FC+COGEN-SIM) (\*)
- Annex 43: Testing and Validation of Building Energy Simulation Tools (\*)
- Annex 44: Integrating Environmentally Responsive Elements in Buildings (\*)
- Annex 45: Energy Efficient Electric Lighting for Buildings (\*)
- Annex 46: Holistic Assessment Tool-kit on Energy Efficient Retrofit Measures for Government Buildings (ENERGo) (\*)
- Annex 47: Cost-Effective Commissioning for Existing and Low Energy Buildings (\*)
- Annex 48: Heat Pumping and Reversible Air Conditioning (\*)
- Annex 49: Low Exergy Systems for High Performance Buildings and Communities (\*)
- Annex 50: Prefabricated Systems for Low Energy Renovation of Residential Buildings (\*)
- Annex 51: Energy Efficient Communities (\*)
- Annex 52: Towards Net Zero Energy Solar Buildings (\*)
- Annex 53: Total Energy Use in Buildings: Analysis and Evaluation Methods (\*)
- Annex 54: Integration of Micro-Generation and Related Energy Technologies in Buildings (\*)
- Annex 55: Reliability of Energy Efficient Building Retrofitting - Probability Assessment of Performance and Cost (RAP-RETRO) (\*)
- Annex 56: Cost Effective Energy and CO<sub>2</sub> Emissions Optimization in Building Renovation
- Annex 57: Evaluation of Embodied Energy and CO<sub>2</sub> Equivalent Emissions for Building Construction (\*)
- Annex 58: Reliable Building Energy Performance Characterization Based on Full Scale Dynamic Measurements (\*)
- Annex 59: High Temperature Cooling and Low Temperature Heating in Buildings (\*)
- Annex 60: New Generation Computational Tools for Building and Community Energy Systems
- Annex 61: Business and Technical Concepts for Deep Energy Retrofit of Public Buildings
- Annex 62: Ventilative Cooling
- Annex 63: Implementation of Energy Strategies in Communities
- Annex 64: LowEx Communities - Optimized Performance of Energy Supply Systems with Exergy Principles
- Annex 65: Long-Term Performance of Super-Insulating Materials in Building Components and Systems
- Annex 66: Definition and Simulation of Occupant Behavior in Buildings
- Annex 67: Energy Flexible Buildings
- Annex 68: Indoor Air Quality Design and Control in Low Energy Residential Buildings
- Annex 69: Strategy and Practice of Adaptive Thermal Comfort in Low Energy Buildings
- Annex 70: Energy Epidemiology: Analysis of Real Building Energy Use at Scale
- Annex 71: Building Energy Performance Assessment Based on In-situ Measurements
- Annex 72: Assessing Life Cycle Related Environmental Impacts Caused by Buildings
- Annex 73: Towards Net Zero Energy Public Communities
- Annex 74: Energy Endeavour
- Annex 75: Cost-effective Building Renovation at District Level Combining Energy Efficiency and Renewables
- Working Group - Energy Efficiency in Educational Buildings (\*)
- Working Group - Indicators of Energy Efficiency in Cold Climate Buildings (\*)
- Working Group - Annex 36 Extension: The Energy Concept Adviser (\*)
- Working Group - HVAC Energy Calculation Methodologies for Non-residential Buildings

## Acknowledgements

The “Deep Energy Retrofit Pilot Projects” report was developed within the IEA EBC Program Annex 61, “Business and technical Concepts for Deep Energy Retrofit of Public Buildings” as the result of a joint effort by researchers and practitioners from Austria, Canada, China, Denmark, Estonia, Germany, Latvia, UK, and the United States. The authors express their appreciation to the many international contributors and organizations whose volunteer efforts contributed to development of a series of Guides developed under this project. Special gratitude to the ASHRAE and its Technical Committees TC 7.6 “Building Energy Performance,” TC 5.2 “Duct Design,” and a Standing Standard Project Committee 90.1 for providing a platform for public discussion of the project progress and to Chartered Institution of Building Services Engineers (CIBSE) for sharing its technical information and providing valuable input into these documents. The authors would like to personally thank the members of the EBC Program Executive Committee for their directions, guidance, and support to the project. Special appreciation to the following reviewers, who provided their valuable comments and suggested improvements to this Guide: Prof. J. Owen Lewis, José A. Candanedo and Ken Church (Natural Resources Canada). The authors gratefully acknowledge William J. Wolfe, Writer-Editor, ERDC-CERL for his help in coordinating the preparation of this document. The authors would like to acknowledge the financial and other support from the following: the office of the Assistant Secretary of the US Army for Installations, Energy, and Environment; US Army Corps of Engineers; US Department of Energy (Federal Energy Management Program), The Austrian Ministry for Transport, Innovation and Technology, the EUDP-programme of the Danish Energy Agency and Bundesministerium für Wirtschaft und Energie, Germany.

## Abstract

The implementation of deep energy retrofits (DER) is still not common practice. The way to combine energy conservation measures (ECMs) in an efficient least-cost way, the synergies between ECMs, the quality assurance mechanisms, and the methods to finance and implement DER are still far from being common knowledge. In the context of the research work of IEA EBC Annex 61, the objective of Subtask C was to implement pilot projects on the basis of the knowledge collected in the Annex 61 working group. Subtask C specifically targeted the documentation of the use of cost-optimized applications of the core bundle of technologies defined in Subtask A; the use of different financing instruments, business models and acquisition strategies collected by the Subtask B team and summarized in the DER Business Guide; and the evaluation of the use of quality assurance methods throughout all phases of the project to better guide prospective DER project stakeholders.

The goal of the assessment was to generate helpful information for decision-making, technical design, financing, and implementation such as:

- Brief description of the building before the retrofit (energy use intensities (EUIs), climate zone).
- Motivation to engage in a DER.
- A list of major ECMs implemented.
- Financing instruments and business models used (energy performance contracting, owner-directed public investment, or others).
- Investment costs per m<sup>2</sup> or per ft<sup>2</sup>.
- Post refurbishment EUIs.
- Payback period.
- Lessons learned and guidance for future DER projects.

This Subtask C report provides brief summaries of seven projects, the degree to which they met their objectives, their relevance to the core and advanced ECMs identified in Subtask A, applications of DER business models identified in Subtask B, and lessons learned. Full case studies are given for five of the seven projects. The other two case studies have been published in the Subtask A report, and the summary section of this report provides updated data on their post-retrofit operational performance.



## Foreword from the Annex 61 Operating Agents

Many governments worldwide are setting more stringent targets for reduction of energy use in government/public buildings, to take the lead and show the right direction for a sustainable future. However, the funding and “know-how” (applied knowledge/experience) available for owner-directed energy retrofit projects have not kept pace with the new requirements. This is clearly shown by the fact that the reduction of energy use in typical retrofit projects varies between 10 and 20%, while experiences from executed projects around the globe show that reductions can exceed 50% and that renovated buildings can cost-effectively achieve the Passive House standard or even approach net zero energy status. Therefore, there is a need for good examples of Deep Energy Retrofit (DER).

Research under the IEA EBC Program Annex 61 has been conducted with a goal of providing a framework, selected tools, and guidelines to significantly reduce energy use (by more than 50%) in government and public buildings. The project scope was limited to public buildings constructed before the 1980s with low internal loads (e.g., office buildings, dormitories, barracks, public housing and educational buildings) undergoing major renovation. One of the Annex 61 deliverables is the book of “DER Energy Retrofit – Case Studies,” which contains 26 well documented case studies from Europe (Austria, Denmark, Estonia, Germany, Ireland, Latvia, Montenegro, The Netherlands, United Kingdom) and the United States. After these data were collected, the case studies were analyzed with respect to energy use (before and after renovation), reasons for undertaking the renovation, co-benefits achieved, resulting cost effectiveness, and the business models followed. Finally, the lessons learned were compiled and compared.

Based on extensive literature review and lessons learned from these case studies, the IEA EBC Annex 61 team has proposed the following definition of the DER:

Deep Energy Retrofit (DER) is a major building renovation project in which site energy use intensity (including plug loads) has been reduced by at least 50% from the pre-renovation baseline with a corresponding improvement in indoor environmental quality and comfort.

Lessons learned from case studies and experiences of the team allowed to conclude, that DER can be achieved with a limited core technologies bundle readily available on the market. Characteristics of some of these core technology measures depend on the technologies available on an individual nation’s market, on the minimum requirements of national standards, and on economics (as determined by a life cycle cost [LCC] analysis). Also, requirements to building envelope-related technologies (e.g., insulation levels, windows, vapor and water barriers, and requirements for building airtightness) depend on specific climate conditions. Characteristics of these technologies and best practice examples of how to apply them in different construction situations have been documented in another Annex 61 deliverable – “Deep Energy Retrofit – A Guide to Achieving a Significant Energy Use Reduction with Major Renovation Projects.” Analysis of case studies also contributed to development of business models and project financing options, including those based on advanced Energy Performance Contracting (EPC), which are described in the “Deep Energy Retrofit Business Guide.”

Some of the concepts described in these Guides and their combinations have been tested and further studied during the Annex 73 using the following pilot projects:

- Dormitory in Manheim, Germany.
- Institute Wohnen und Umwelt (IWU) Office Building in Darmstadt, Germany.
- Almegårds Kaserne Military Barracks in Bornholm, Denmark.
- Presidio Military Barracks in Monterey, California, USA.
- Federal Building and Courthouse in St. Croix, U.S. Virgin Islands.
- Federal Buildings, Silver Spring, MD, USA.
- Kindergarten, Estonia (Estonia).

Due to a relatively short duration of the Annex 61 (3 years) these pilot projects had different starting points and objectives, and resulted in different depth and breadth of information obtained. The objectives varied from testing if DER can be achieved with recommended Energy Conservation Measure (ECM) bundles, cost effectiveness of DER compared to building a new facility, application of ECMs in combination with renewable energy (RE) sources to achieve net zero energy building in a cost-effective way and demonstrating EPC as a means to finance a DER project.

Also, these pilot projects succeeded in documenting:

- How much energy savings was achieved in comparison to the energy baseline and to the predictions and modeling results.
- Whether the project was cost effective, and how the cost effectiveness was achieved.
- Which financing and business models were used to implement.
- Lessons learned from DER project implementation, which can benefit future projects.

Alexander Zhivov, Ph. D.  
Senior Research Engineer, U.S. Army ERDC  
Co-Operating Agent, IEA Annex 61

Rüdiger Lohse  
KEA  
Co-Operating Agent, IEA Annex 61

## List of Abbreviations

Abbreviations	Meaning
ASHRAE	American Society of Heating, Refrigerating and Air-conditioning Engineers
BAS	Building Automation system
Btu	British Thermal Unit
CHP	Combined Heat and Power
DH	District heating
DHW	Domestic Hot Water
DE	Germany
DER	Deep Energy Retrofit
DK	Denmark
DOAS	Dedicated Outdoor Air System
DOE	Department of Energy (U.S.)
DRM	De-risking Measures
EN	European Norm
EPBD	Energy Performance of Buildings Directive
EPC	Energy Performance Contracting
ECM	Energy Conservation Measure
EDLIG	Energy services for Deep Refurbishments (German research project)
ESCO	Energy Service Company
ESM	Energy Supply Measures
EST	Estonia
ESPC	Energy Savings Performance contract
EU	European Union
EUI	Energy Use Intensity
FBE	Danish Defense Construction and Infrastructure organization
FEMP	Federal Energy Management Program
GSA	General Services Administration (U.S.)
h	Hours
HAZMAT	Hazardous Materials
HP	Heat pump
HVAC	Heating, Ventilation and Air-Conditioning
IEA EBC	Energy in Buildings and Communities Programme of the International Energy Agency
IMVP	International Measurement and Verification Protocol
IWU	Institute Wohnen und Umwelt
kBtu	Thousand Btu
KEA	Klimaschutz–und Energieagentur (in Baden-Württemberg, Karlsruhe, Germany)
KfW	Kreditanstalt für Wiederaufbau (Germany)
kWh	Kilowatt hours: 1 kWh = 3.6 MJ
$\Lambda$	Lambda-Value (value for the insulating capacity of a material)
LCC	Life Cycle Cost
LED	Light-Emitting Diode
M&V	Measurement and Verification
MBtu	Million Btu
NCFB	New Carrollton Federal Building

NZEB	Nearly zero energy building or nearly zero emissions building
NZE	Near Zero Energy (EU) / Net Zero Energy (USA)
O&M	Operations and maintenance
PHPP	Passive House Planning Package
PV	Photovoltaic
QA	Quality Assurance
QC	Quality Control
Ref	Reference
RE	Renewable energy (sources)
SOW	Scope of work
SSMC1	Silver Spring Metro Center #1
SWMA	South West Mannheim Association
SWOT	Strengths, Weaknesses, Opportunities, Threats
UK	United Kingdom
USA	The United States of America
USACE	U.S. Army Corps of Engineers
VAT	Value-added Tax
VfW	German Association of Heating Suppliers, Chapter EPC
W	Watts
yr	Year

## Table of Contents

<b>INTRODUCTION</b>	<b>1</b>
<b>1. PROJECT SUMMARIES AND ANALYSIS</b>	<b>2</b>
1.1. PROJECT OBJECTIVES AND ACCOMPLISHMENTS .....	3
1.2. PROJECT SUMMARIES .....	7
1.3. OVERALL CONCLUSIONS AND LESSONS LEARNED .....	14
<b>2. APPENDICES: CASE STUDIES</b>	<b>19</b>

## Tables and Figures

### Tables

1-1	Core bundles of technologies implemented in DER related to climate zones .....	4
1-2	ECMs and RE technologies implemented .....	12
1-3	Forecasted and actual energy and water use of the Silver Spring Project .....	13
1-4	Overview of Subtask C case studies .....	18
2-1	Ludwig Frank Quartier buildings .....	20
2-2	Overall concept for DER of Bldg. 42 in 3 packages .....	24
A-1	Ludwig Frank Quartier heating baseline and benchmarks .....	29
A-2	Ludwig Frank Quartier power baseline and benchmarks .....	30
A-3	Global cost baseline Ludwig Frank Quartier .....	30
A-4	Predicted energy savings .....	30
A-5	Cost optimization of the DER EPC project at Ludwig Frank Quartier .....	31
A-6	Rating criteria for the evaluation of reliability of business models .....	34
A-7	Award criteria of business as usual EPC and DER EPC Mannheim .....	39
B-1	Characterization of the IWU Darmstadt modeling case study .....	40
B-2	Lifetime periods and average maintenance costs according to VDI 2067 .....	45
B-3	Corner points of the economic modeling of the Darmstadt case study .....	46
B-4	Technical description of scenarios (SI Units) of the Darmstadt case study .....	48
B-5	Technical description of scenarios (I-P Units) of the Darmstadt case study .....	49
B-6	Fuel-specific primary energy and CO <sub>2</sub> -equivalent factors (including all greenhouse gas emissions) used in Germany (Jank, 2015) .....	54
B-7	Site and source energy EUIs .....	55
C-1	U-values and $\Psi$ -values .....	70
C-2	Calculated annual energy use reduction for Demonstration 1 .....	75
C-3	Calculated annual energy use reduction for Demonstration 2 .....	75
C-4	Almegårds Project energy target .....	75
C-5	Net present value analyses .....	76
C-6	Cost effectiveness for LARGE action .....	77
D-1	DER EnergyPlus kBtu/ft <sup>2</sup> modeling results for Bldg. 630 .....	86
D-2	Cost breakdown for example DER measure yielding net first cost savings .....	89
D-3	Summary of key energy system performance requirements in the RFP .....	90

D-4	PDQA used to identify roles and responsibilities associated with DER milestones .....	93
D-5	Summary of prescriptive RFP consideration for DER projects .....	95
D-6	Tightness requirements for the first wing were met, but individual areas (windows and roof) showed slight leakage .....	100
E-1	Measured energy savings.....	110
E-2	Costs for each measure .....	111

## Figures

A-1	Aerial view of Ludwig Frank Quartier .....	19
A-2	Scheme of new mechanical ventilation system with fresh (green), inlet (red), outlet (brown) and exhaust air (yellow) applied in Bldg. 43.....	23
A-3	Thermal photography of Bldg. No. 42 .....	23
A-4	Insulation composite system for Bldg. 42 with high resistant layers .....	25
A-5	Existing ventilation system exhaust air uptake in the sanitary rooms above WC.....	26
A-6	Existing district heating station .....	26
A-7	Scheme of the secondary heating and domestic hot water circuit of Bldg. 3.....	28
A-8	New pre-fabricated and insulated district heating station .....	28
A-9	Ludwig Frank Quartier BAS scheme .....	29
A-10	Cumulative payback .....	32
A-11	SWOT analysis of reliability criteria of business models .....	34
B-1	Front view from the street on the southern part of the building before refurbishment (Darmstadt case study).....	40
B-2	Specific investment costs of measures and measure bundles of the Darmstadt case study.....	47
B-3	U-value of external wall (red curve and left vertical scale) and insulation costs (right vertical scale) as function of thickness (heat transfer coefficient = 0.035 W/m <sup>2</sup> K) .....	51
B-4	Energy savings per U-value improvement in the Darmstadt case study.....	53
B-5	Investment costs and heating loss reduction.....	53
B-6	NPV of different scenarios of energy-related investment costs per m <sup>2</sup> .....	56
B-7	NPV of different scenarios of global costs per m <sup>2</sup> .....	57
C-1	Bldg. 3 of Almegårds Kaserne.....	61
C-2	Master plan of the military establishment Almegård Kaserne. In the upper part of the plan is the demonstration area, with Bldg. 3, the DER case .....	65
C-3	Close-up of the demonstration area. Case study Bldg. 3 is located at the left .....	65
C-4	Floor plan of Bldg. 3 with the energy retrofit measures .....	66
C-5	Construction details on a section of the study case Bldg. 3 .....	66
C-6	Construction details on a section of the study case Bldg. 3 .....	67
C-7	New initiatives for case study Bldg. 3.....	68
C-8	Rendering of the new Bldg. 3 façade .....	68
C-9	Solar collector of 500 m <sup>2</sup> .....	73
C-10	Wind Turbine (25 kW <sub>p</sub> ).....	73
D-1	(a) Bldg. 630's 3-story barracks wings (1-story connecting structure is administrative spaces that are not part of the case study), (b) uninsulated concrete masonry unit (CMU) walls and single-pane windows—typically left open year-round for ventilation—make for poor building envelope performance.....	81
D-2	Bldg. 630 Natural gas usage .....	83

D-3	The Army's updated barracks room layouts provides more space and improved indoor environmental quality through forced air ventilation and better controllability of HVAC systems .....	83
D-4	Flow diagram indicating the interconnectedness of many HVAC and DHW systems .....	84
D-5	Representation of EnergyPlus modeling of Bldg. 630 .....	86
D-6	Gutted exterior (a) and the interior (b) of Bldg. 630 .....	88
D-7	PDQA process deliverables such as window mock-ups can be effective QA tools when used correctly .....	94
D-8	Improvements to the existing air barrier design drawing (a) required: (b) air barrier testing, (c) paint-on air barriers at the window, and (d) improved window details .....	98
D-9	Ductwork joint seals (a) alone that did not meet DALT criteria; insulation provided (b) .....	99
D-10	System diagram of Bldg. 630's closed loop hydronic system (design errors shown in red) .....	99
D-11	Areas for improvement: (a,b) roof air barrier detail as compared was included in the design, (c,d) slight leakage at the overhang, (e,f) contact of thermal barrier and exterior stairway steel supports still acts as thermal bridge .....	101
D-12	Completed first wing of Presidio Bldg. 630 .....	103
E-1	Almeric Christian Federal Building and Courthouse.....	105
E-2	Monthly building energy use and PV electricity production .....	109
E-3	Example daily load and PV curves .....	109





## Introduction

IEA ECB Annex 61 has investigated deep energy retrofits (DER) of existing buildings, i.e., projects that reduce the building's energy use by 50% or more. Subtask A collected case studies of 26 previous projects that achieved, or attempted to achieve, 50% energy savings. These projects were studied to identify the "bundles" of energy conservation measures (ECMs) that were implemented and that worked together synergistically, how the energy conservation achieved compared to the energy and cost baseline, the specific costs for the DER, and which business model was in use for the implementation. Thus, the objective of Subtask A was to investigate and improve the *technical feasibility* of DER projects.

Subtask B examined financial instruments, life cycle-cost-based energy and non-energy benefits, and business models that improve the *financial feasibility* of DER based on advanced Energy Performance Contracting (EPC). The decision criteria and performance metrics used to evaluate financial feasibility were also identified.

Unlike Subtasks A and B, which focused on previous projects, the objective of Subtask C was to assemble case studies of *current* DER projects that applied the instruments developed in Subtasks A and B. This report contains those case studies, analyzes them, and draws conclusions and lessons learned aimed at helping future projects achieve DER.

Subtask C included seven case studies:

- Dormitory in Mannheim, Germany.
- IWU Office Building in Darmstadt, Germany.
- Almegårds Kaserne Military Barracks in Bornholm, Denmark.
- Presidio Military Barracks in Monterey, California, USA.
- Federal Building and Courthouse in St. Croix, U.S. Virgin Islands.
- Federal Building and Metro Center in Silver Spring, Maryland, USA.
- Kindergarten in Valga, Estonia.

The technical and financial concepts of the Darmstadt office building, Silver Spring federal building, and Valga kindergarten case studies were included in the Subtask A report. Only summaries of the Silver Spring and Valga projects will be given here. The Darmstadt project write-up in Subtask A documented the modeling process. In this Subtask C report it is updated with performance information.

These case studies are evaluated against the following metrics using metered data if available and recalibrated simulation model results if data were not available:

- What ECMs were implemented, and how do these compare with the core bundle of ECM technologies identified in Subtask A?
- How much energy savings was achieved in comparison to the energy baseline (i.e., was it a deep retrofit?) and in comparison to the predictions and modeling results?
- What was the overall project's objective(s)?
- What business models, identified in Subtask B, were used?
- Was the project cost-effective?
- What were the lessons learned or design guidance derived to benefit future projects?

## 1. Project Summaries and Analysis

Case Number	Country	Location	Building Type	Photo
1	Germany	Mannheim	Dormitory	
2 (Subtask A Case 11)	Germany	Darmstadt	Office Building	
3	Denmark	Almegårds Kaserne	Barracks	
4	United States	Monterey, CA	Barracks	
5	United States	St. Croix, U.S. Virgin Islands	Federal Building / Courthouse	
6 (Subtask A Case 21)	United States	New Carrollton / Silver Spring, MD	Office Building and Metro Center	
7 (Subtask A Case 4)	Estonia	Valga	Kindergarten	

## 1.1. Project Objectives and Accomplishments

The seven Subtask C DER projects were initiated for numerous reasons related to reducing net operating costs; meeting mandated performance standards; increasing a building's asset value; developing business models to finance physical improvements; achieving sustainability, self-sufficiency and/or energy security targets; and/or bringing older buildings up to modern standards for performance, comfort and air quality, and aesthetics. The primary technical and financial aspects of the seven DER projects were:

### Technical aspects:

- Use recommended ECM bundles to achieve DER to meet regulatory requirements or sustainability targets.
- Use DER ECM bundles to renovate an old building to equal the quality (comfort, energy efficiency, aesthetics, etc.) of a new building, but for less than the cost of constructing a new facility.
- Use DER ECMs to help make a building net zero or near net zero energy.

### Financial aspects:

- Implement DER cost-effectively, if possible using EPC business models as a means to finance the DER project.
- Implement DER ECMs during major building renovation; and demonstrate that their incremental cost is less than the financial benefits of increased energy efficiency.

This section summarizes how successful the seven DER projects were in achieving their objectives, based on the summary project narratives (Section 1.2) and the Detailed Case Studies (Appendices).

### 1.1.2. Objective 1: Implementation and evaluation of recommended cost-optimized ECM bundles resulting from the modeling process to achieve DER cost-effectively

Five of the seven projects sought to demonstrate the technical- and cost-effective implementation of DER ECM bundles to meet EUI targets. The cost effectiveness of DER was considered with regard to the global refurbishment costs:

- Dormitory in Mannheim, Germany.
- IWU Office Building in Darmstadt, Germany.
- Federal building and metro center in Silver Spring, Maryland, USA.
- Federal building and courthouse in St. Croix, U.S. Virgin Islands.
- Kindergarten in Valga, Estonia.

Cost-effectiveness of the marginal costs of additional energy efficiency measures to achieve a DER was evaluated for the Presidio project (Objective 5, Section 1.1.4). The Almegårds Kaserne project (as well as the Presidio and Mannheim projects) demonstrated the cost-effectiveness of renovating an older building compared to constructing a totally new building (see Objective 2, Section 1.1.3). All seven projects showed the value of the DER core bundle ECMs identified by modeling and/or implementing portions of the core ECM bundles. Table 1-1 lists the ECM measures and bundles that each project implemented. Bundles of technologies identified in Subtask A are outlined in red.

Table 1-1. Core bundles of technologies implemented in DER related to climate zones.

ECM:	Wall insulation	Roof insulation	Floor/basement ceiling insulation	New window/ door	Daylight Strategy/external shading	Efficient lighting/control	BEMS (Building Energy Management)	Mechanical Ventilation Heat Rec.	New ventilation system	New heat-cooling supplier/distribution	Hydronic heat supply incl. radiators,	Air-/LA) /Ground-source (G) heat numm	Combined Heat. Power or Biomass	Solar thermal system	Photovoltaic panels(P)/Wind energy(W)	District Heating Improvement
Case study:																
Dormitory, Mannheim, DE	✓	✓	✓	✓	✓	✓		✓	✓	✓	✓		CHP	✓	✓	✓
Passive House Office, Darmstadt, DE	✓	✓	✓	✓		✓		✓	✓		✓					✓
Barracks, Almegards Kaserne, DK	✓	✓		✓	✓	✓		✓	✓		✓			✓	W	✓
Kindergarten, Valga, Estonia	✓	✓	✓		✓	✓		✓	✓	✓				✓		
Office Building, Maryland, USA		✓		✓		✓	✓	✓	✓	✓	✓	✓	✓	✓	P	
Presidio of Monterey, CA, USA	✓	✓	✓	✓	✓	✓	✓	✓	✓	✓	✓			✓		
Federal Building, St. Croix, VI, USA				F			✓	✓	✓						P	

Notes: CLIMATE ZONE: green cz 6a; orange = cz 4a; pink cz 5a; dark blue cz 1; light blue cz 3c

F = window film

W = Wind turbine

P = Photovoltaic panels

The Darmstadt and Estonian projects used Passive House design principles. The Mannheim dormitory adopted new building standards that were 40% better than current requirements; that project is still under construction. To achieve DER in these climate zones, the European projects had to improve the thermal envelope significantly, with associated investment costs of 200 – 550 €/m<sup>2</sup>. Their DER refurbishment greatly increased the air tightness of the buildings. To maintain required air exchange rates, those buildings had to add forced air ventilation systems that added to the project costs and energy use (about 5 – 10 kWh/m<sup>2</sup> yr).

Two U.S. buildings – Silver Spring and St. Croix – were already equipped with ventilation systems. Here the ECM bundle was focused on heating, ventilation, and air-conditioning (HVAC) measures that were combined with renewable energy (RE) – especially for St. Croix – and on partial improvements of the thermal envelope.

### **1.1.3. Objective 2: Renovate an older building for less than the cost of a total rebuild**

The following projects demonstrated the efficacy of using DER design principles to renovate an older building to match the energy use efficiency of new construction for less than the cost of demolition and rebuild:

- Almegårds Kaserne Military Barracks in Bornholm, Denmark.
- Presidio Military Barracks in Monterey, California, USA.
- Dormitory, Mannheim, Germany.

In addition to the energy efficiency and financial aspects of this objective, there is an important aesthetic one: the desire to show that the renovated buildings could be equal to any newly-constructed building in terms of comfort, appearance, functionality, and ease of access.

All three of the projects with this objective accomplished the renovation for much less than a demolition/rebuild would have cost. Presidio was less than 50% of the new construction price. The presence of hazardous materials in the Presidio barracks further validated this approach, as some of the material could remain undisturbed, avoiding additional large remediation costs.

In Mannheim, the preliminary project study estimated total rebuilt costs (including demolition and disposal costs) for dormitory buildings at 1.140 €/m<sup>2</sup> net floor area; the costs of a comparable major renovation combined with a DER was calculated at less than 350 €/m<sup>2</sup>.

### **1.1.4. Objective 3: Use ECMs to make a building Net Zero or Near Net Zero Energy**

One project was set up to combine DER with a Near Zero Energy approach:

- Federal building and courthouse in St. Croix, U.S. Virgin Islands.

The energy efficiency measures (36% energy reduction) for the St. Croix project significantly reduced the number of photovoltaic panels (PV) that would be needed to make the building net zero. However, net zero energy (NZE) has not yet been achieved. Post-installation metered data show that periodic unavailability of some photovoltaic (PV) panels, as well as periods of higher than expected building energy use, have prevented it from actually being net zero more than about 10% of the time so far.

The total investment costs of \$6.25 million were mostly evenly divided between HVAC measures and PV and were, except for a small share of appropriated funding, provided by an ESCO under an Energy Savings Performance contract (ESPC). By integrating PV into the ECM bundle, and because of the high cost of electricity (\$0.36/kWh), it was possible to finance the total investment costs within a payback period of 19.6 years.

### **1.1.5. Objective 4: Implement DER cost-effectively, if possible using EPC business models as a means to finance the DER project**

Five projects demonstrated the cost-effectiveness of DER, where reduced energy and maintenance costs and/or increases in the value of the building offset the DER investment on a Net Present Value basis:

- Dormitory in Manheim, Germany.
- IWU Office Building in Darmstadt, Germany.
- Federal building and metro center in Silver Spring, Maryland, USA.
- Kindergarten in Valga, Estonia.
- Federal building and courthouse in St. Croix, U.S. Virgin Island.

EPC has been shown to be a desirable business model for DER by enabling the investment to be financed with future savings, often in such a way that the project investment does not appear as a liability on the account books of the building owner (see Annex 61 Subtask B report). Consequently, a concurrent objective was to take advantage of the cost effectiveness of a DER project to use the EPC business model. Three projects successfully used ESPC to implement a DER project:

- Dormitory in Mannheim, Germany.
- Federal building and Courthouse in St. Croix, U.S. Virgin Islands.
- Federal building and Metro Center in Silver Spring, Maryland, USA.

Typically, ESPC project savings in the United States and Europe have been between 20 and 30%; hence, ESPC has not been considered to be a viable financing tool for DER or NZE. The projects described here made key adjustments to the traditional ESPC model. With these adjustments in place, ESCOs were able to provide competitive ESPC bids for these three DER projects:

**Specifications:** The building owners developed functional specifications in which the ESCO was required to propose a project that met the DER energy-saving targets. This required early cooperation between the building owner and the ESCO in planning and structuring the projects. For the United States, the building owner (GSA) held design charrettes, collaboratively screening ECMs and ECM bundles to arrive at mutually agreed-upon energy savings targets. For the German project, the building owner and the project facilitator conducted a feasibility study to specify cost-effective ECM bundles.

**Risk mitigation of tendering and bid costs:** To date, German ESCOs have not been required to provide a savings guarantee with the refurbishment of the thermal envelope. Requiring such a savings guarantee added a significant risk to the ESCO, and would normally result in a much higher bid price for implementation. To reduce costs and risks for the ESCOs, the specification in the tendering documents included some basic architectural requirements that defined the design of some details (window design, colors, fire protection measures, the minimum air ventilation rate, etc.). Also, the building owners provided the ESCOs with a modeling tool for the calculation of the energy savings of the required energy-saving measures. The model was recalibrated and filled with all baseline data, building data, U-values, etc. This allowed the ESCOs make their calculations on a mutually agreed-upon accurate basis, so if the construction elements were implemented and maintained properly, the owner agreed with the model's predicted savings.

**Risk mitigation in the performance of new or advanced ECMs:** In a "normal" ESPC contract, the ESCO is responsible for the guaranteed energy savings as well as all maintenance and repair of the ECMs over the contract period. For the Mannheim project, achieving DER required implementation of ECMs that, compared with a typical project's ECMs, were more complex and more expensive, and for which the ESCO had less construction and implementation experience. (Typical German ESPC projects required investments of 80-100 €/m<sup>2</sup>; the DER ESPC project's investment costs were about 350 €/m<sup>2</sup>.) To mitigate these risks, the DER EPC contract gave the ESCO an extended period to adjust and commission the ECMs, providing an "optimization period" of 2 years before the ESCO was required to fully achieve the savings guarantee. In addition, the maintenance of the thermal envelope and the new windows was limited to 5 years (within the total contract period of 16 years).

### 1.1.6. Objective 5: Demonstrate marginal cost effectiveness of additional energy efficiency possible when implementing advanced ECMs during major construction/renovation projects

- Presidio of Monterey, CA, USA.

One of the major strategies to improve cost effectiveness of DER implementation is to combine DER with major renovations. The thesis is that the incremental costs of adding conservation measures will be small compared to the building's renovation budget for the envelope, interior, and major systems (including electrical, plumbing and HVAC). As an example, adding polystyrene insulation to a building's exterior is seldom cost-effective as a standalone project, but if the building's facade is being replaced and renovated, the cost of installing external insulation is primarily the incremental material costs, with minimal labor.

For a DER project, the additional costs to improve beyond minimum energy efficiency requirements are likely to be recouped by the additional energy savings from DER. Referring to the previous example, the additional cost of installing 15 – 20 cm (6 – 8 in.) of polystyrene for DER versus 2.5 – 5 cm (1 – 2 in.) polystyrene (meeting minimum EUI requirements) is quite small (e.g., adding 10 – 15% to the material costs), as the labor and most of the insulation material costs are included in the 2.5 – 5 cm (1 – 2 in.) of external insulation.

While several projects have shown that building renovation is often less expensive than demolishing and replacing an old building, the cost effectiveness of implementing DER during such a major renovation has so far been proven only on a planning and simulation/modeling level. Preliminary estimates of the additional incremental investment costs ( $\approx \$330/\text{m}^2$ ) versus additional incremental energy savings ( $\approx \$6.80/\text{m}^2\text{-yr}$ ) for improving from the Army's required EUI of  $126 \text{ kWh}/\text{m}^2\text{-yr}$  to the DER EUI of  $82 \text{ kWh}/\text{m}^2\text{-yr}$  indicates an extended simple payback period. It is hoped that future metered data from the U.S. Presidio project will provide additional measurement and verification (M&V) evidence.

In the United States, the improved energy efficiency of the barracks was important to meet U.S. Army and U.S. Government objectives of transitioning to NZE facilities for energy efficiency and energy security reasons. If the value of lower facility energy use in terms of these factors could be monetized and included in the building life cycle cost (LCC) analysis, as is suggested in the Subtask B analysis of DER business models, then the additional investments in ECMs to achieve DER may show a positive net present value.

## 1.2. Project Summaries

This section presents summaries of the seven projects.<sup>1</sup> Five full Subtask C case studies are given in the Appendices. The other two have been published in the Subtask A report.

### 1.2.1. Dormitory, Mannheim, Germany

Eight student residences in the Ludwig Frank Quartier will undergo renovations and upgrades to building insulation, the ventilation system, lighting, the heating grid, and the domestic hot water system. Photovoltaic panels, a combined heat and power plant, and a building automation system will also be added to substitute power supply from the grid and to improve the cost effectiveness of the DER project. The objective of these retrofits is to reduce energy

---

<sup>1</sup> Note that several of the projects provide only estimated savings – metered data post-retrofit are either not available or the building owner has not provided the information. However, simulation models are estimates. In this report, model outputs are given as stated by the case study authors. As a result, data as presented may contain more significant figures than warranted by a modeling exercise and thus may appear overly precise.

consumption by over 50% compared to student residences that have not been refurbished. The project was carried out as the first DER ESPC in Germany that included a performance guarantee for the thermal insulation of buildings.

Total retrofit energy cost savings are estimated to be 185.8 k€, or 7.2 €/m<sup>2</sup>/yr (0.67 €/ft<sup>2</sup>/yr). The bundling of ECM and ESM (energy supply measures) can increase the cost effectiveness of a DER ESPC significantly and thereby reduce the investment and performance risks for the ESCOs. In the Ludwig Frank Quartier the combination of HVAC measures and PV in seven buildings and the combined heat and power (CHP) and DER in one building can provide a payback period of 17.4 years (simple or static payback of 13.8 years) related to the global investment costs and without any seed money. The simple payback period was further shortened to 16 years by adding the avoided maintenance and refurbishment costs into the savings guarantee of the ESCO. The project has been in the implementation phase in Spring 2017.

#### **Experience & Lessons Learned:**

- Market development for DER EPCs must be carried out in a joint effort of building owners, ESCOs, facilitators, financiers, and experts from the technical side.
- In preparing the DER ESPC contracts, the project development, implementation structures, award criteria, tendering processes, and the DER design had to be considered carefully to mitigate the risks.
- One major part of the risk mitigation process was to develop a detailed maintenance plan and finance plan to mitigate maintenance cost and interest rate risks resulting from longer DER EPC contract periods. In addition, the building owners provided the ESCOs with a calibrated modeling tool for the calculation of the energy savings of the required energy-saving measures (Passive House Planning Package PHPP). The ESCO was also allowed 2 years to optimize and streamline the project after implementation before the savings guarantee enters into force.
- The cost effectiveness of DER ESPC was improved by 32% by integrating avoided maintenance and replacement costs into the EPC financing scheme.
- Modifying normal EPC award criteria to give a monetary value to sustainable technical concepts can improve the cost effectiveness.

#### **1.2.2. IWU Office Building, Darmstadt, Germany**

The refurbishment of an office building in Darmstadt, Germany involved the installation of improved insulation in the roof, walls, basement ceiling and windows; ventilation with heat recovery; lighting controls; and shading. These efforts aimed to reduce the energy consumption of the building by improving its energy efficiency.

Calculated energy savings total 81% at the site and 76% at the source, or 208 kWh/m<sup>2</sup>/yr at the site and 235 kWh/m<sup>2</sup>/yr at the source. The energy use intensity (EUI) is calculated to drop from 256 kWh/m<sup>2</sup>/yr to 48 kWh/m<sup>2</sup>/yr at the site and from 307 kWh/m<sup>2</sup>/yr to 72 kWh/m<sup>2</sup>/yr at the source.

After the building renovations in 2012/2013 to achieve the Passive House level of energy use, 2 years of energy data have been collected. The collected data show that the actual heating energy use of the building in 2013/2014 was about 5% higher than what was estimated through calculations. This results in 78% heating energy savings (51 kWh/m<sup>2</sup>/yr for heating and domestic hot water with a payback time of 28 years) for the global investment costs. The incremental DER costs have a payback of 11 years.



The expanded modeling analysis shows that, to improve the cost effectiveness of the DER project, the performance specification, requirements for the design detailing and implementation of window replacement, and mitigation of thermal bridges had to be considered very carefully in the request for proposals. A driver for cost effectiveness is the least-cost planning calculation to streamline and fine tune the design of the bundles of DER measures.

The project was carried out in an “owner-directed” business model in which the building owner is finally responsible for the energy efficiency and cost effectiveness of the implemented DER measures.

**Experience & Lessons Learned:**

- Successfully bundled advanced and complementary ECMs to achieve DERs with savings of 78%. In the economic analysis, only energy savings were considered, resulting in a payback period for the global costs of the DER and the repurposing of the building of 28 years. If avoided maintenance costs are also considered, the simple payback is reduced by 4 years to 24 years.
- Verified the strict quality assurance process guidance provided by the building owner throughout all project phases (e.g., blower door tests, thermography).
- The refurbishment was carried out by means of detailed technical design plans for the major thermal bridges and detailed attachment plans for the airtight layers.
- Identified areas where more prescriptive design and construction criteria are recommended for future DER projects.

**1.2.3. Almegårds Kaserne Barracks, Bornholm, Denmark**

A military barracks in Bornholm, Denmark was renovated to meet the Danish Building Regulations, which require the energy consumption to be reduced by a minimum of 30 kWh/m<sup>2</sup>/year, or that the renovation adhere to a table of recommended U-values. Improvements include new insulation, low energy windows, a mechanical ventilation system with heat recovery, the installation of LED lights and lighting controls, new heat piping, low-flow water fixtures, a solar heating system, and the installation of a windmill.

The building upgrades reduced the net heating consumption by 69%, or 101.8 kWh/m<sup>2</sup>, and reduced electricity consumption by 45.6%, or 15 kWh/m<sup>2</sup>. The installation of RE sources further reduced heat and electricity consumption from the grid by 47.5 and 65%, respectively. Total reductions of grid-sourced heat and electricity amount to 123.1 kWh/m<sup>2</sup> for heating and 26.7 kWh/m<sup>2</sup> for electricity.

**Experience & Lessons Learned:**

- It is possible to renovate an older building to achieve energy efficiencies and indoor conditions comparable to a new building, at less than the cost of demolishing the old building and constructing a new one.

**1.2.4. Presidio Army Barracks, Monterey, CA USA.**

One barracks at Presidio of Monterey was upgraded to meet current occupancy, safety, comfort, and energy efficiency standards. Refurbishment included improved insulation; a low temperature, hydronic radiant heating system; low-flow water fixtures; installation of compact fluorescent and LED lighting; installation of Energy Star appliances; and improved energy and water metering.

Using simulated data, the project expected to achieve an 80% site energy use reduction:

- Pre-retrofit energy use: Site 415 kWh/m<sup>2</sup>/yr (131 kBtu/ft<sup>2</sup>/yr).
- Predicted (modeled) energy: Site 82kWh/m<sup>2</sup>/yr (26 kBtu/ft<sup>2</sup>/yr).
- This is a predicted site energy use reduction of 80%.

Because the building was scheduled for occupation in the fall of 2016, only very preliminary post-retrofit metered data are available at this time. Those metered data in the first few months of occupancy shows the total EUI at 40 kBtu/ft<sup>2</sup> (126 kWh/m<sup>2</sup>), a 70% energy reduction from pre-retrofit performance, and just meeting the current U.S. military requirement of 40.1 kBtu/ft<sup>2</sup>/yr. The EUI included 26.5 kBtu/ft<sup>2</sup> for gas and 13.4 kBtu/ft<sup>2</sup> for electrical. This is higher than was expected; a major factor is that the solar thermal DHW system is not fully operational yet; it is producing only 10% of the expected DHW load instead of 70% designed. When fully operational, the solar thermal DHW system should reduce the EUI by an additional 6.6 kBtu/ft<sup>2</sup> (20.8 kWh/m<sup>2</sup>), resulting in an EUI of 33.4 kBtu/ft<sup>2</sup> (105.3 kWh/m<sup>2</sup>), which would be a 75% EUI reduction over pre-renovation performance.

The high pre-retrofit of “baseline” energy use is for an overcrowded building (250 person occupancy versus 150 person occupancy under current military standards). As part of the general renovation, the common latrine (requiring high ventilation rates using outdoor air) has been replaced with personal bathrooms in each two-person module within the building. Before the renovation, building residents were asked to keep their windows open all the time due to the odors, and consequently the heat was on 24 hours a day. Much of the old HVAC equipment was non-functional. Thus, a major portion of the predicted energy savings due to the retrofit is assumed to result from being able to close the windows and allowing the heating system to cycle, instead of heating constantly. The resulting model predictions are that the post-retrofit EUI of 26 kBtu/ft<sup>2</sup>/yr aims at an 80% reduction over pre-retrofit EUI of 131.4 kBtu/ft<sup>2</sup>/yr, and an additional 35% reduction beyond current military requirements of 40.1 kBtu/ft<sup>2</sup>/yr. Because the renovated building was occupied towards the end of 2016, metered data are not yet available to verify performance.

#### **Experience & Lessons Learned:**

- An enhanced quality assurance process is needed to ensure that critical DER milestones are achieved, especially to implement rigorous air infiltration standards.
- A major factor in achieving high levels of energy efficiency is meeting the U.S. Army Corps of Engineers (USACE) building infiltration standard,<sup>2</sup> which is far more rigorous, for example, than ASHRAE 90.1 or 189.1. Successfully meeting this standard requires rigorous quality control and inspection of all phases of design and construction.
- The quality assurance and training methods demonstrated in this project will be valuable for future projects. An example is requiring jobsite window mock-ups. This helped ensure that enhanced envelope air tightness and thermal leakage performance requirements were met by allowing all quality assurance personnel the opportunity to review or approve the mock-up version. Several fenestration design, product, and installation deficiencies were identified in the mock-up; this avoided having to correct the deficiencies after inspection and testing when all windows were in place.
- Several DER features at Bldg. 630 may have benefited from shifting the balance towards more prescriptive and less performance-based request for proposal (RFP) requirements.

---

<sup>2</sup> 0.25 cfm/ft<sup>2</sup> at 0.3 in. w.g. (1.25 L/s m<sup>2</sup> at 75 Pa). See Whole Building Design Guide, “U.S. Army Corps of Engineers Air Leakage Test Protocol for Building Envelopes,” 2012. <http://tinyurl.com/ldx6tyz>

- A better approach would have required building-level controls that met project needs for fine interval commissioning trends, adequate operational memory, and informational energy sub-meter displays in corridors while using separate contract means to later integrate to the base-wide front-end when ready.
- Either specify each known modeling constraint in the RFP along with the performance targets, or use the pre-design model to list each of the prescriptive requirements for system selection and operation without mandating additional energy modeling from the contractor.
- A combination of written requirements and prohibitions, coupled with clear drawings of acceptable examples, should be included in future RFPs.
- A good process to identify hazardous materials (HAZMAT) in the RFP will lead to more accurate estimates by bidders and fewer change orders.

### **1.2.5. Federal Building, St. Croix, U.S. Virgin Islands**

The Almeric Christian Federal Building/Courthouse in the U.S. Virgin Islands was retrofitted to minimize total energy use, maximize RE, and upgrade equipment as needed. The objective was to make the building NZE with respect to the electric grid; this means that the energy demand of the building and the PV energy production are balanced over an annual time period. A 36% reduction in energy use was targeted with the installation of photovoltaic panels, window films, HVAC occupancy-based controls; and replacement of air handling units, the primary transformer, and the building automation system.

The system was designed to reduce energy consumption by 343,772 kWh/yr, or 36%, with the remaining 619,259 kWh supplied by PV panels at the site. The PV was sized to provide 103 – 105% of expected building energy use over the year.

Post-project metered data show that periodic unavailability of a number of PV panels, as well as periods of higher than expected building energy use, have prevented it from actually achieving NZE more than about 10% of the time as of the writing of this report.

#### **Experience & Lessons Learned:**

- Net zero projects are less affected by fluctuations in the cost of electricity from the utility.
- The use of an ESPC allowed rapid implementation of the project without requiring appropriated funding.
- A high level of collaboration was achieved during the development and planning phase, resulting in significant user input to the design and a high acceptance of the project.
- Periodic unavailability of a number of the PV panels plus higher than expected building energy use have so far prevented the building from actually achieving net zero operation.
- Care must be taken in estimating the benefits of reduced utility charges from achieving net zero. That is, net zero does not ensure a \$0 electric utility bill; there could be customer, standby, and/or demand charges as well as time-varying energy rates. As larger numbers of customers install PV panels, most utilities are imposing other requirements and modifying net metering tariffs.

### **1.2.6. Federal Building and Metro Center, Silver Spring/New Carrollton, Maryland, USA.**

The full case study with a detailed description of the project has been documented in the Subtask A report as Case Study #21. This section presents and evaluates the measured and verified performance data.

In 2012, the U.S. General Services Administration (GSA) competitively challenged energy service companies (ESCOs) to improve the energy performance of 30 GSA-owned buildings through ESPCs featuring innovative solutions to achieve maximum energy savings. This project is a comprehensive ESPC addressing over 1 million ft<sup>2</sup> of office space at the New Carrollton Federal Building (NCFB) in Lanham, Maryland and the Silver Spring Metro Center one building (SSMC1) in Silver Spring, Maryland. The ECMs were designed to exceed the DER goal of 50% energy savings and increase the overall value of the facility (Table 1-2).

Table 1-2. ECMs and RE technologies implemented.

ECM	NCFB	SSMC1
Lighting Upgrades and Advanced Lighting Controls	X	X
Complete Upgrade of Building System Controls	X	X
Premium Efficiency Motors	X	X
Water Conservation	X	X
Building Envelope Improvements	X	X
High-Efficiency Transformers	X	X
Chilled Water System Improvements		X
Ventilation Air System Optimization		X
HVAC Upgrades to Chillers/Heater with Geothermal	X	
875 kW Solar PV System	X	
Solar Thermal System	X	
Domestic Water System Optimization	X	
Exhaust to Outside Air Energy Recovery	X	
Kitchen Exhaust Controls	X	
Electric and Telephone Room Cooling System Upgrades	X	

The baseline energy consumption of the buildings was based on metered data for calendar years 2009 through 2011; these buildings consumed, on average, 151,368 MBtu (44,361,587 kWh) at a cost of \$3,850,000 annually for energy (electricity and natural gas). In addition, the buildings used an average of 31,689 kgal (119,950 l) annually for potable water at a cost of \$498,000 for water and sewer services. The project was designed to reduce energy use by 61% in NCFB and 47% in SSMC1. Estimated annual reductions in energy and water use were:

- Electricity: 27,714,088 kWh/yr; \$2,451,191.
- SSMC1: 47%, 8,705 MMBtu (2,551,183 kWh).
- NCFB: 61%; 81,919 MMBtu (24,008,092 kWh).
- PV at NCFB is designed to provide 1,154,149 kWh/yr.
- Water: 17,025 kgal/yr (64,447l/yr); \$192,927.
- 

Table 1-3 lists the pre-retrofit energy and water consumption, predicted post-retrofit use, and actual fiscal year 2016 (September 2015 – August 2016) metered data. The metered data validate that the project is achieving its energy savings targets, but not its water reduction targets. Non-energy benefits of the project include:

- Reduces ongoing maintenance; operation and maintenance (O&M) savings of over \$68,000 per year.
- Promotes overall energy awareness.
- Reduces approximately 22,000 metric tons of CO<sub>2</sub>.
- Creates/sustains approximately 550 jobs.

Table 1-3. Forecasted and actual energy and water use of the Silver Spring Project.

Facility	Case (Pre-Retrofit, Designed, Actual)	Energy		Water	
		Use (kWh)	Cost	Use (kgal)	Cost
NCFB	Pre-Retrofit	38,915,740	\$3,334,000	29,126	\$460,000
	Designed Usage (65% less meter)	13,753,499			
	Designed Energy Savings (61%)	24,008,092			
	PV Designed	1,154,149			
	Total Designed Meter Decrease	25,162,241			
	FY2016 Actual Use * (66% less meter)	*13,363,524	*\$1,598,934	21,477	\$339,843
SSMC1	Pre-Retrofit	5,445,847	\$516,000	2,563	\$38,000
	Designed Usage	2,894,664			
	Designed Energy Savings (47%)	2,551,183			
	FY 2016 Actual Use* (35% savings)	*3,543,875	*\$457,048	2,666	\$50,958
TOTAL	Pre-Retrofit	44,361,587	\$3,850,000	31,689	\$498,000
	Designed Usage (62% less meter)	16,648,163	\$1,398,809	14,664	\$305,073
	Designed Savings (60%)	26,559,275	\$2,451,191	17,025	\$192,927
	FY 2016 Actual Use *(62% less meter)	*16,907,399	*\$2,055,982	24,143	\$390,081
* FY 2016 actual energy use and cost is electricity only. (Gas was less than 0.5% of total building energy use.) Actual energy use and cost are not weather-adjusted. Actual costs may also be different from forecasted costs because of tariff adjustments.					

#### Experience & Lessons Learned:

- GSA's strategy of requiring ESCO bidders to propose ambitious ECMs to achieve a DER that was cost-effective as an ESPC was successful. This project is meeting its 60% energy reduction goals.

#### 1.2.7. Kindergarten, Valga, Estonia

The full case study was described in Subtask A report as Case Study #4; meanwhile, the measured and verified performance data have become available. The project was designed to modernize a kindergarten building built in the 1960s and also to expand the partial second floor to increase the building's capacity. Passive House design principles were used to improve energy efficiency. This included:

- Solar heating for domestic hot water and to augment the space heating system.
- Additional thermal insulation for the walls 37 cm (14.6 in.) and roof 50 cm (19.7 in.).
- Tightening the building envelope to reduce infiltration.
- New energy efficient windows.
- A new ventilation system with heat recovery.

The initial goal was to achieve 20 kWh/m<sup>2</sup> (6.3 kBtu/ft<sup>2</sup>yr) net space heat demand (pre-project use was 280 kWh/m<sup>2</sup> (88.8 kBtu/ft<sup>2</sup>yr). During implementation, because of an inaccuracy in the specification documents, the construction company installed a lower cost ventilation unit that also had a lower energy efficiency than had been anticipated originally. With this less

efficient ventilation equipment, the energy goal was readjusted to 40 kWh/m<sup>2</sup> (12.7 kBtu/ft<sup>2</sup>yr). However, the actual energy consumption after installation was 83 kWh/m<sup>2</sup> (26.3 kBtu/ft<sup>2</sup>yr), which is a 30% energy reduction.

The installed building envelope measures met the calculated U-values:  $U_{\text{walls}}$  0.10 W/(m<sup>2</sup>K),  $U_{\text{roof}}$  0.10 W/(m<sup>2</sup>K),  $U_{\text{windows}}$  0.6 W/(m<sup>2</sup>K),  $q_{50}$  0.41 m<sup>3</sup>/(m<sup>2</sup>·h) resulted in a specific heat loss per heated area, H/A, of 0.26 W/(m<sup>2</sup>K).

The evaluation of the project revealed many aspects that should be taken into account in future projects, and also issues that are not normally considered as important in the regular building design became apparent. A significant oversight was that the kindergarten personnel were not given instructions for operating the heating/ventilating systems. When room temperatures became too high, the teachers opened the windows, even though it was winter.

#### **Experience and Lessons Learned:**

There were several reasons for the project's not meeting its energy targets. The actual heating energy consumed was much higher than predicted primarily because of problems with the ventilation system:

- Indoor temperatures were kept too high (i.e., overheated building) because the ventilation control system was too simplified, not allowing for variation based on temperature. Designing the heating system without controlling the room temperature by groups of rooms led to continuous overheating of the majority of rooms.
- The actual electricity consumption 41 kWh/m<sup>2</sup> (13.0 kBtu/ft<sup>2</sup>yr) was much higher than the targeted 12 kWh/m<sup>2</sup> (3.8 kBtu/ft<sup>2</sup>yr) because the ventilation unit used about five times more electricity than expected. The controls were not set accurately or working properly: the time schedules for fans were not functional. During an inspection, the fans were found to be operating constantly 24 hours a day and 7 days a week; this exceeded the modeled usage hours by 65%.
- The installed heat recovery system was less effective than expected. The heat consumption for preheating the ventilation supply air exceeded the modeling results because the ventilation system was designed and operated in a way that did not even partly allow the use of recirculated air for space heating. Thus, the full air flow to heat the rooms came from outdoor air.
- The high ventilation rate also resulted in indoor air that was too dry for comfort.
- Two other factors that led to higher than expected energy consumption were that assumptions about the amount of internal heat gains were too optimistic, and the modeling had overestimated the building's heat retention (storage) capability.
- Building occupants must receive proper training on operating advanced heating systems. An easy means to regulate temperatures and ventilation rates must be provided.
- The ventilation system must be compatible with advanced heating technologies. A variable air volume system with proper controls would have helped the building improve its energy use and made the indoor humidity more acceptable.

### **1.3. Overall Conclusions and Lessons Learned**

Seven case studies were initiated in Subtask C to achieve the DER goal of a 50% or more reduction against the energy consumption baseline before the refurbishment. Five of those seven are already providing measured and verified performance data after the DER

refurbishment; two of those projects failed to achieve the DER goals, while three projects were successful. Which lessons and which conclusions can be drawn from a comparative evaluation of the different projects?

The major outcomes of these projects are:

- A DER can be implemented with advanced EPC models within a payback period of 16 to 25 years and less (St. Croix, Mannheim, Silver Spring) when global DER costs, including all energy-related investments are considered.
- The benefits of DER projects used to determine cost effectiveness may include not only reduced energy costs, but also reduced or avoided maintenance costs. For example, the avoided maintenance costs were accounted for in the Mannheim case study and improved the overall cost effectiveness of the DER concept by 15%.
- Another positive impact initiated by the DER is the improved reliability of the renovated systems. These could be credited as avoided closedown-costs of a facility due to failures of HVAC, lighting, process heating, or other energy-related systems. However, the value of increasing the reliability has not been captured in the Subtask C case studies. This also applies to the increased indoor climate quality and building comfort that are cited in at least three of the pilot case studies. Until now, these costs have not been considered in financial accounting, especially that of public building owners.
- By reducing a facility's need for energy, a DER project lessens the amount of fossil and renewable energy (e.g., photovoltaics) needed to make the building NZE in energy with respect to off-site energy sources. The inclusion of renewables can have a positive impact on energy security, as well as reducing greenhouse gas emissions. However, none of the retrofit concepts aimed at a full independence from grid (i.e., NZE implies an exchange of energy with the grid, not a separation from it). The case in Mannheim shows that the integration of renewables into the DER scheme may reduce high-priced energy purchase from the grid by 33% and thus increase the cost effectiveness of the DER concept (dynamic payback period) by 30%.
- A major cost effectiveness instrument is to use a least-cost planning calculation to streamline and fine tune the design of the bundles of DER measures. The German cases demonstrate a methodology to implement least-cost planning so the combined impact of each measure is optimized with regard to the related investment costs.
- In Climate Zone 5a the core DER ECM bundles includes major improvements to the thermal envelope with average U-values for the wall of 0.2, windows of 1.3, and roof insulation of 0.25–0.3 W/m<sup>2</sup>K. The most common measures inside the building were recent lighting refurbishment using LED technology or at least T5 lamp systems. The evaluated buildings in Climate Zone 5a are in Europe; before the refurbishment the buildings had only small exhaust air units but no major AC nor ventilated heating. These pilot projects were very representative of the building stock in Climate Zone 5a, having no cooling system before refurbishment. To maintain and control the air exchange rate, the uncontrolled window ventilation had to be replaced by new air-conditioning systems: either centralized systems or DOAS were implemented. With the new ventilation system, the power consumption increased by 5 – 10 kWh/m<sup>2</sup>yr while the investment costs increased by 30 – 80€/m<sup>2</sup> (first investment costs for the ventilation system including distribution ducts).
- In most climates where air-conditioning is required, the DER concept has to consider

the improvement of cooling efficiency by using exhaust air energy recovery, by variable use of outdoor air depending upon temperature and indoor air quality, and by using appropriate heat pump technology.

- In the Presidio of Monterey case study, the DER concept was combined with a major renovation of the building structure that allowed the implementation of significant measures at the thermal envelope.
- In the United States, the business models used were: (1) EPC combining public funding with private sector financing, with repayment coming from avoided energy and maintenance costs; and (2) implementing advanced ECMs when undertaking major renovation with the use of appropriated government funds. The public sector in the United States considers EPC as the primary way to finance DER projects and has been able to use this to extend the scope of available public funding. EPC is far more widespread in the United States than in the other countries participating in Annex 61.
- In Europe, one case (Mannheim) was implemented by using an advanced DER EPC business model. The reason for this decision was the recent performance of some DER projects carried out in the “business as usual” business model: a couple of DER refurbished buildings failed the energy-saving targets by 80%. The EPC project in Mannheim combined public funds and private financing, with 15% of the total investment costs provided by public grant programs and the remaining 85% financed by the ESCO. The financing model was based on the savings guarantees provided by the ESCO: the building owner has only to pay (“pay as you save”) the measured and verified savings in energy costs, reduced maintenance costs, and savings from fuel switching.
- In one project (St. Croix) the selection of an ESCO and an EPC business model did not prevent the project from failing the energy efficiency targets; the “pay as you save” principle can allow the building owner to transfer the risk for underperformance to the ESCO’s side and pay only the reduced saving amount to the ESCO.
- The other European projects implemented DER technologies in conventional business and financing models: after a feasibility study, the building was modeled and the project planned by an architect or energy consultancy. Then the implementation was undertaken by construction companies. The responsibility and risk for the savings and cost effectiveness remained with the building owner; the major decision-making criterion in this model is usually the first investment cost. This way of thinking in business as usual projects was demonstrated in one project (Estonia): here the construction company changed the installation plan and selected a less expensive ventilation system to save investment costs. The evaluation of this project showed that the ventilation system underperformed and the project drastically failed to meet the calculated energy efficiency targets.
- In general, European public authorities tend to not initiate DER projects if the funding is not available; another option is a staged refurbishment. The usage of ESPC to extend scarce public funding sources<sup>3</sup> and to increase refurbishment activity is still not commonly understood or widely used in Europe.
- GSA’s strategy (for numerous projects) has been successful in developing cost-effective DER projects with ESPC financing (ESPCs are the form of EPC most often used in the United States). GSA sets an ambitious energy-saving goal (i.e., a DER project) and

---

<sup>3</sup> ESCO 2015 Report, JRC, Ispra, 2015



requires the ESCOs to develop a cost-effective design. This facilitates innovation, and helps GSA to enforce performance because GSA does not have to specify, and thus guarantee or stipulate performance of, the advanced ECMs.

- An important aspect of combining DERs with major renovations is the inclusion of specific performance requirements into the Owners' Project Requirements section of contractual documents, to include site and source energy targets, minimum requirements for building insulation levels, building and ductwork air tightness, equipment performance, HVAC controls schedules and sequence of the control systems, etc.
- The quality assurance (QA) process should be executed throughout all phases of the project. For more advanced technologies and more stringent performance requirements usually associated with DER projects, standard QA and commissioning methods are not sufficient.
- When implementing an energy-saving project with advanced and/or complex HVAC systems, it is essential that: (1) building occupants receive sufficient training on operating the system and when to call for repairs/service, and (2) the occupants must be able to easily adjust indoor temperature and ventilation rates.
- Occupants of a building must be trained in the correct use of the refurbished building's systems, especially advanced ECMs and ECM bundles, to achieve the performance targets and maintain comfort.

Table 1-4 lists the ECMs used, and the costs and savings of the seven Subtask C DER projects. The projects are characterized by building usage, climate zone, and the status of the data (design phase or verified data after implementation). Data presented include:

- The EUIs and the savings for site energy consumption (electricity and heating) per m<sup>2</sup> and ft<sup>2</sup> net building floor space.
- The costs of the ECM bundles – both the global and the DER-specific costs (including VAT) per m<sup>2</sup> net building floor space. The costs show large variations, influenced by the design of the bundles, the overall project size (net building floor space), ECM availability and individual component costs in different countries, the partition of construction measures, indoor insulation, and other investment cost drivers.
- The cost effectiveness is displayed in terms of the static payback period.

Table 1-4. Overview of Subtask C case studies.

Case Study	1	2	3	4	5	6	7	8	9
	ASHRAE climate zone	Building type / net floor area m <sup>2</sup> / ft <sup>2</sup>	EUI ex ante (kWh/m <sup>2</sup> ·yr) / kBtu/ft <sup>2</sup> ·yr	EUI ex post (kWh/m <sup>2</sup> ·yr) / kBtu/ft <sup>2</sup> ·yr	Global Investment costs per floor space	DER partition of investment costs per floor space	Energy cost savings per floor space and %	Other accounted cost savings	Payback (years) related to global (5.) or DER (6.) investment costs
1	Dormitory, Mannheim, Germany	Dormitories 14604 m <sup>2</sup> / 157000 ft <sup>2</sup>	115/36	40/12.6 (dg)	292 €/m <sup>2</sup> (dg)	263 €/m <sup>2</sup> (dg)	3.1 €/m <sup>2</sup> ·yr (dg)	4.1 €/m <sup>2</sup> ·yr (dg)	16 (for 5.)
2	Office Building, Darmstadt, Germany	Office 1680 m <sup>2</sup> /18083 ft <sup>2</sup>	307 / 94	72 / 22 (v)	960 €/m <sup>2</sup> (v)	492 €/m <sup>2</sup> (v)	27 €/m <sup>2</sup> ·yr / 76% (v)	-	28 (for 5.) / 11 (for 6.)
3	Barracks, Almegård, Denmark	Barracks 1460 m <sup>2</sup> /15700 ft <sup>2</sup>	178 / 54	63 / 19 (d)	696 €/m <sup>2</sup> (d)	696 €/m <sup>2</sup> (d)	8.2 €/m <sup>2</sup> ·yr (d)	-	>50 (5.)
4	Kindergarten, Varga, Estonia	Kindergarten 1156 m <sup>2</sup> / 12442ft <sup>2</sup>	280/85	83/25 (v)	1,295€/m <sup>2</sup> (v)	1,295€/m <sup>2</sup> (v)	-6,6 €/m <sup>2</sup> ·yr (v)	-	>50 (for 5.)
5	Office Building, Silver Spring, MD USA	Office	380/116	145/44	378 US\$/m <sup>2</sup>	378 US\$/m <sup>2</sup>	17.2US\$/m <sup>2</sup> ·yr (v)	0.56US\$/m <sup>2</sup> (1) 3.3US\$/m <sup>2</sup> (2)	22 (for 5.)
6	Barracks, Presidio Monterey, CA, USA	Barracks 6045 m <sup>2</sup> /65000 ft <sup>2</sup>	415/132	82/26 DER (126/40.1 required min.) (d)	\$359/ft <sup>2</sup> /\$3,860/m <sup>2</sup>	\$30/ft <sup>2</sup> / \$330/m <sup>2</sup> [estimated]	\$0.63 /ft <sup>2</sup> ·yr / \$6.80/m <sup>2</sup> ·yr for DER \$46.89/m <sup>2</sup> for global project	n.a.	48 for DER increment > 50 (for 5.) [estimated]
7	Federal Building/Courthouse, St. Croix, VI, USA	Courthouse 7082m <sup>2</sup> /76227 ft <sup>2</sup>	132/40	30/9.2	899 US\$/m <sup>2</sup> (v)	899 US\$/m <sup>2</sup> (v)	71 US\$/m <sup>2</sup> (v)	-	20 (for 5.)

The indices (in parentheses) refer to the data evaluation status:  
(d) = a designed/calculated value that has not yet been verified;  
(dg) = a designed/calculated value that is guaranteed by an ESCO  
(v) = monitored and verified values  
(1) = avoided maintenance costs  
(2) = water and sewage cost savings

## 2. Appendices: Case Studies

### Appendix A: Dormitory, Mannheim, Germany

#### A.1. Name of the project, location

Student residences in Mannheim, Germany.

#### A.2. Pictures of the buildings and building descriptions/typology

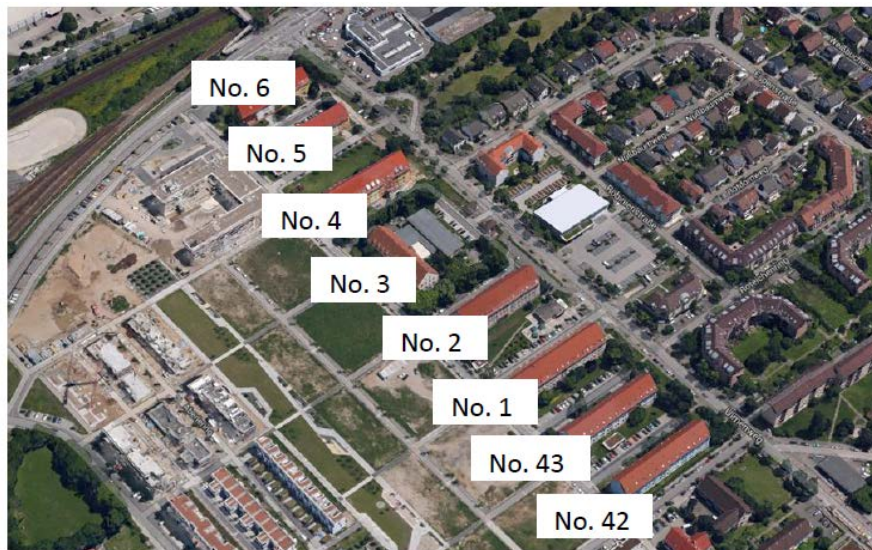

Figure A-1. Aerial view of Ludwig Frank Quartier.

With a history starting in the 1930s as a Wehrmacht casern, the Ludwig Frank Quartier still has four former crew accommodation buildings from that time period (No. 1, 2, 3, and 4). After World War II, the quartier was heavily destroyed and was used by the U.S. Army. In the 1960s, Bldgs. No. 42, 43, 5 and 6 were constructed. Since 1994, the SW Mannheim Association (SWMA) took ownership and started a major renovation (1994 – 1998), which reshaped the floor plans, updated fire protection and accessibility, refurbished the infrastructure, connected to the Mannheim district heating utility (based on a waste combustion CHP plant with a primary energy factor of 0.65), and installed a new canteen with gas-powered cooking facilities.

#### A.3. Project summary

##### Project objectives

The eight student resident houses in the Ludwig Frank Quartier originated in the 1930s and 1960s; they were transformed from their former function as military staff living quarters into student residences in the mid-1990s. In 2008, the roofs of all eight houses were insulated. In three houses, the windows have been renewed and the facades insulated.

Now the heating systems need renovation. The building owner decided not to do only

what was most necessary, but also to implement a whole bundle of measures: a combination of high performance envelope requirements; HVAC and lighting systems; and photovoltaic (PV) power generation. This will be achieved using EPC, where the ESCO invests, finances, implements and operates the ECMs. EPC provides a performance-related remuneration scheme for the building owner (“pay as you save”), which can be considered debt-neutral. The target was to achieve energy savings of greater than 50% compared to the energy baseline for heating and power in the not yet refurbished houses.

### Short project description

The energy savings for a number of different energy renovation measures, the estimated cost of the implementation of each measure, and thereby the payback period for each measure have been calculated. The following key improvements are suggested:

- Insulation of the building shell of one of the not yet insulated buildings, and installation of a ventilation system with heat recovery of at least 75%.
- Photovoltaic system.
- New district heating grid with CHP.
- Water-saving concept.
- Modernization of lighting.

### Project developer

- Kapitel Unternehmensberatung für Energiedienstleistungen, Bruchköbel.
- KEA Klimaschutz und energieagentur Baden-Württemberg, Karlsruhe.

### A.4. Stage of construction

Eight houses built in different years.

Table 2-1. Ludwig Frank Quartier buildings.

No.	Picture	Year of construction, inhabitants	Floor space	Recent refurbishment
42, 43		1960, 97 inhabitants	2.666 m <sup>2</sup> (28.697 ft <sup>2</sup> )	2008 Refurbishment of the roof with 18 cm mineral wool in the roof and new roof windows

1, 2		1933, 139 inhabitants	3.691 m <sup>2</sup> (39.730 ft <sup>2</sup> )	2008 Refurbishment of the roof with 18 cm mineral wool in the roof and new roof windows
3		1933, 44 inhabitants, Restaurant in ground floor	2.790 m <sup>2</sup> (30.032 ft <sup>2</sup> )	2008 Windows partially refurbished, refurbishment of the roof with 18 cm mineral wool in the roof
4		1933, 110 inhabitants	3.200 m <sup>2</sup> (34.444 ft <sup>2</sup> )	2010 All Windows and entrance doors renewed refurbishment of the roof with 18 cm mineral wool in the roof, insulation of the facade 14cm, basement ceiling 10 cm,
5, 6		1960, 88 inhabitants	2.257 m <sup>2</sup> (24.294 ft <sup>2</sup> )	2008 All Windows and entrance doors renewed refurbishment of the roof with 18 cm mineral wool in the roof, insulation of the facade 14cm, basement ceiling 10 cm,

#### A.5. Point of contact information

Martina Riel, KEA Klimaschutz und Energieagentur Baden-Württemberg, Kaiserstr. 94a, 76133 Karlsruhe.

#### A.6. Date of the report

November 2016.

#### A.7. Acknowledgment

The development of this project is supported by the Federal Ministry for Economic

Affairs and Energy through the Project Management Jülich, support number 03ET1170A.

### **A.8. Site**

Location: Mannheim, Germany.

Latitude: .48E.

Longitude: 49.49N.

Elevation: 92 m.

Climate zone: ASHRAE 90.1-2007: 5/ warm temperate.

Cooling Degree Days: none.

Heating Degree Days: G 15: 1792 Kd.

### **A.9. Building Description/Typology**

#### **Typology/Age**

1933-1960.

#### **Type**

Residential buildings.

#### **General information**

Year of construction: 1933 – 1960.

Year of previous major retrofit: 2008.

Year of renovation (as described here): 2017.

Total floor area (in eight buildings): 14,604 m<sup>2</sup> 157,196.1 ft<sup>2</sup>.

Area of unconditioned space included above (m<sup>2</sup>): 0 m<sup>2</sup>.

#### **Architectural and other relevant drawings**

Figure A-2 shows the scheme of new mechanical ventilation system Thermal photography (Figure A-3) shows how much the building users affect the energy balance of the building. The construction shows thermal bridges at the roller shutter box above the window. Also the uninsulated basement with uninsulated district heating house stations are very visible. The effect of the many pivot-hung and open windows on a cold autumn day (ambient temperature 6 °C/42.8 °F) is obvious; it shows the importance of a well-working ventilation system, behavior training and a well-balanced heating system.



Figure A-2. Scheme of new mechanical ventilation system with fresh (green), inlet (red), outlet (brown) and exhaust air (yellow) applied in Bldg. 43.

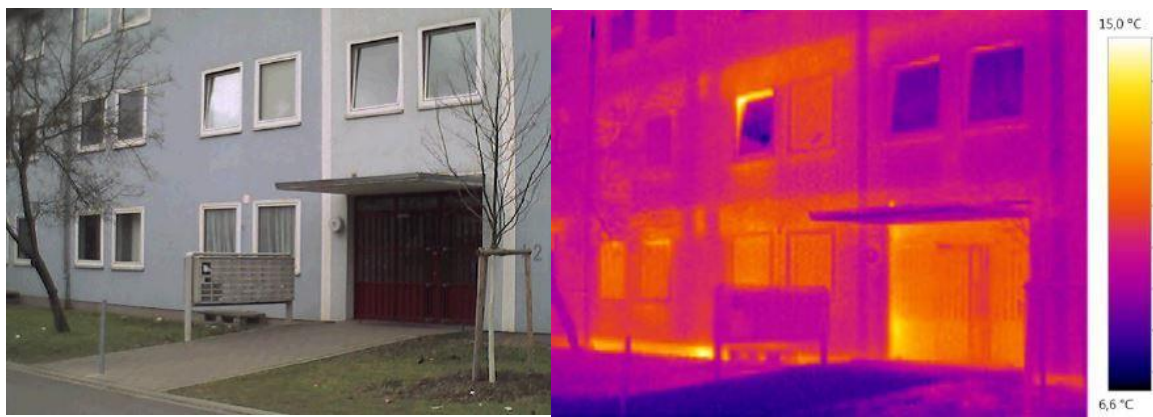

Figure A-3. Thermal photography of Bldg. No. 42.

#### A.10. National energy use benchmarks and goals for building type

In Bldg. 42 the DER measure bundle has to be optimized by combining the not cost-effective thermal envelope with more cost-effective HVAC measures. Table 2-2 summarizes DER simulation results using the PHPP and two additional packages applied on the DER of Bldg. 42 and an overall supply solution. The existing building model had been back-calibrated against utility data to within a 0.2% discrepancy; the occupancy was assumed constant. For the DER of Bldg. 42 the following can be said:

- The ESCOs exceeded the minimum requirements in the specifications by at least 15% better energy refurbishment values.
- The DER with its measures related to the envelope reduced the energy demand by 57% at costs of 209 €/m<sup>2</sup> (19.35 €/ft<sup>2</sup>).
- The addition of HVAC measures, such as district heating station and DHW, achieved additional savings of 11% (site energy) at 54 €/m<sup>2</sup> (5.1 €/ft<sup>2</sup>) investment costs.
- An increase of the overall cost efficiency of the Ludwig Frank Quartier and the cost efficiency of Bldg. 42 was achieved by setting up a district heating and micro power grid to distribute the PV and CHP power produced among the eight buildings.

Table 2-2. Overall concept for DER of Bldg. 42 in 3 packages.

(kWh/m <sup>2</sup> yr. and kBtu/ft <sup>2</sup> )	Site EUI	Source EUI	vs. Site Existing	vs. Source Existing	Specific Investment Costs (€/m <sup>2</sup> )
Existing (metered and calibrated)	115 (36.4)	117 (37.1)	-	-	-
Energieeinsparverordnung [“Energy Saving Ordinance”] (EnEV) minimum requirement: national standard for new buildings	83 (26.3)	86 (27.3)	27%	26%	170
V1 Enhanced Envelope Including Ventilation	49 (15.5)	52 (16.5)	57%	55%	209
V2 = V1 +HVAC Package	38 (12.0)	40 (12.6)	68%	65%	+54 =263
V3 = V2+ CHP + Gas Peak boiler+ PV package replace District Heating	40 (12.6)	42 (13.3)	76%	74%	+28 =291

### A.11. Site energy cost information

#### Electricity

0.14 – 0.19 €/kWh, depending on time of day.

#### District heating

0.0565 €/kWh.

### A.12. Pre-renovation details of Bldg. 42

#### Envelope details: walls, roof, windows, insulation level

Walls of brickwork: U-value 1.4 W/m<sup>2</sup>K/ 0.24 Btu/h ft<sup>2</sup> °F.

Windows with two pane glazing: U-value 2.8 W/m<sup>2</sup>K/ 0.49 Btu/h ft<sup>2</sup> °F.

Roof insulated with 18cm mineral wool: U-value 0.26 W/m<sup>2</sup>K/ 0.045 Btu/h ft<sup>2</sup> °F.

Cellar ceiling: U-value 1.0 W/m<sup>2</sup>K/ 0.176 Btu/h ft<sup>2</sup> °F.

#### Heating, ventilation, cooling and lighting systems

District heating station without insulation, installed circa 1984.

Exhaust air system without heat recovery.

#### Description of the problem: reason for renovation

The HVAC system is in bad condition and needs refurbishment. The windows and the facade of Bldg. 42 have not been renovated in over 30 years. There is a desire to reduce energy consumption.



## Renovation statement of work (SOW) (non-energy and energy-related reasons)

Now, after 25 years as a student residence and with a high fluctuation in occupancy, the buildings again need a refurbishment to provide sufficient comfort.

### A.13. Energy-saving improvement concepts and technologies used

#### Building envelope improvement

External Wall: reinforced thermal insulation composite system with a U-value of 0.19 W/m<sup>2</sup>K (0.033 Btu/hr\*ft<sup>2</sup>\*°F) is put in place. The construction specification is 160 mm expanded polystyrene, 50 mm of vandalism-resistant extruded foam layers, a double layer of reinforcement and 4 mm of plaster.



Figure A-4. Insulation composite system for Bldg. 42 with high resistant layers.

**Basement ceiling and staircase:** Equipped with 80 mm extruded foam. The requirements for fire protection have been met by using different insulation materials; in the staircases on the external wall in front of the stair cases, the material is mineral wool and plastering, with a U-value of 0.31 W/m<sup>2</sup>K (0.054 Btu/hr\*ft<sup>2</sup>\*°F).

**Windows—triple glazing:** External shutters and burglary-resistant fittings in the first floor; the average U-value of the window is 1.0 W/m<sup>2</sup>K (0.17 Btu/hr\*ft<sup>2</sup>\*°F).

#### New HVAC system or retrofits to existing.

**Space heating:** Currently each apartment's space heating is provided by hydronic radiant heating embedded in the wall under the window. To avoid permanent window ventilation the heating temperature will be reduced to a lower temperature. If the window is open, the low temperature heating will not be able to provide a comfortable indoor temperature and the window will soon be closed by the occupants, as the indoor temperature will decrease very quickly. The space heating is controlled with preset operative-temperature thermostats. Variable flow hot water is supplied from 1.5 m<sup>3</sup> stratified storage tanks connected to the district heating station in the basement.

**Ventilation system:** Currently the building only has an exhaust air system without heat recovery (see Figures A-5 and A-6). As the DER reduces the air leakage dramatically, this system will not be able to provide sufficient air quality. To achieve the minimum air exchange for dormitories (>0.75/h), mechanical ventilation will be provided by two dedicated outdoor air systems (DOAS) with a heat recovery factor of 0.75. The two systems will be equipped with high-efficiency speed-controlled drives. A complete new

duct system will be set up in the building using the old exhaust air chases. The DOAS ventilation system is designed for constant low speed airflow, with noise reduction components in the inlet and outlet air. In addition, 16 fire protection dampers are built in the newly installed ducts. All systems are operated with a digital HVAC building automation systems (BAS).



Figure A-5. Existing ventilation system exhaust air uptake in the sanitary rooms above WC.



Figure A-6. Existing district heating station.

### New Lighting.

For interior lighting, the old T8 and T5 lighting systems will be replaced by LED panel systems with  $8\text{W}/\text{m}^2$  ( $2.53\text{ Btu}/\text{hr}/\text{ft}^2$ ) in apartments and  $4\text{W}/\text{m}^2$  ( $1.27\text{ Btu}/\text{hr}/\text{ft}^2$ ) in the hallways. In the apartment rooms, two 18 W (two 62 Btu/h) T8 lamps will be replaced by one 15 W (51 Btu/h) LED system. In the hallways and staircases, the same LED systems will be implemented as in the apartments, with daylight and occupancy detectors. In the bathrooms, the T8 lamps will be replaced by LED-retrofit lamps of 10W (34.2 Btu/h). In the kitchenettes, the T8 lamps will also be replaced by LED-retrofit sets of 8W (27.4 Btu/h) each. Exterior lighting uses bi-level dimming LED technology.

### **New generation/distribution systems**

**District heating system:** The existing district heating in the Ludwig Frank Quartier has been installed and operated by the Mannheim utilities since 1984. Each building is equipped with a district heating station. These are poorly insulated, the pumps are outdated, and the valves and their electronic drives are at the end of their technical lifetime.

In the EPC project the ESCO will replace the district heating grid and the heating stations by new ones with a heat exchanger and high-efficiency insulation and high-efficiency heating pumps on the secondary side of the heat exchanger. The control system will be connected to the BAS. The new heating stations will reduce the heating losses by at least 50%. On the secondary side the hot water will be distributed by new high-efficiency hot water pumps into the stratified hot water storage tank. The tank is sized with a capacity equal to store 1 hour's maximum heating load. Hence the maximum heating load will be reduced. From the storage tank the hot water is distributed into the heating grid and the domestic hot water station (DHWS) of each building.

**New district heating grid with CHP:** Further cost optimization will be achieved by replacing the existing district heating grid with a new micro-heating grid that connects all eight buildings. In the basement of Bldg. 42, a CHP plant will be installed (50 kW<sub>el</sub>, 92 kW<sub>th</sub>) to provide 52% of heating demand, as well as a natural gas condensing boiler with 1000 kW<sub>th</sub> for peak load provision. To reduce costs for peak boiler loads and to increase the CHP operating hours, a stratified hot water storage tank (12 m<sup>3</sup>) will be included in the system.

**Domestic Hot Water (DHW) System:** Prior to refurbishment DHW is supplied to each apartment suite for showers and sinks from two 1000 liter storage tanks that are heated by the district heating system (Figure A-7). In this project, DHW will be supplied by a flow-type heater system with a small storage tank of no more than 200 liters. With the smaller DHW storage tank, the legal requirements for thermal disinfection of large DHW systems will be avoided. This new system reduces the heating losses of the DHW system by 60%. Circulation will also be improved with this DHW system (see Figure A-8) Instead of storing large amounts of preheated water for circulation, the circulation of DHW will be provided on demand. The DHW system will be connected to the BAS.

**Water-saving concept:** To reduce water consumption, both amount of DHW used and peak demand for DHW, the sinks and showers will be equipped with low-flow fixtures, the toilet flush tank systems will be renewed, and the water pressure will be reduced in each building.

## Renewable energy

**Photovoltaic systems:** PV will be installed on all roofs with a southwest orientation. Because of the German RE regulations, the most cost-attractive approach is to set up 10 kW<sub>peak</sub> PV systems that produce only the amount of power that can be consumed in the buildings; feed-in to the regional grids is not cost-effective. Currently the ESCO is considering the option of setting up a micro power grid. This could increase PV power production by enabling the PV to serve the combined power demand of multiple buildings.

## Other improvements

**Utility Meters:** Electric and water sub-metering is required on each floor. The heating and DHWS systems will be metered separately. Interval and cumulative data are available to SW Mannheim's energy management team as well as to building occupants through hallway displays to foster energy and water usage awareness.

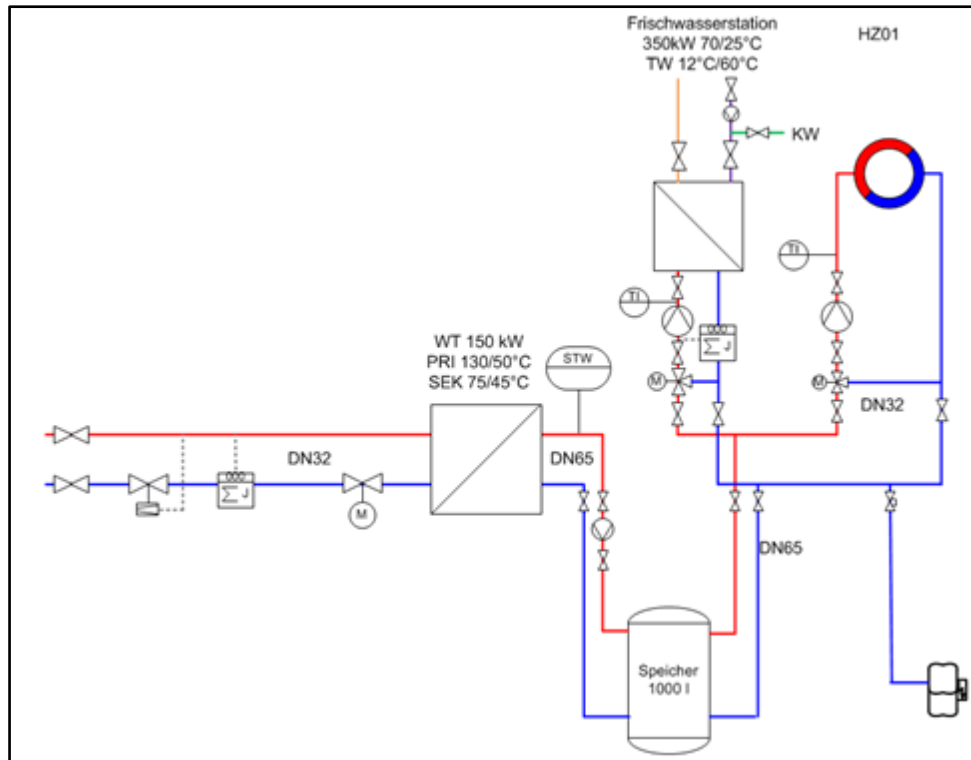

Figure A-7. Scheme of the secondary heating and domestic hot water circuit of Bldg. 3.



Figure A-8. New pre-fabricated and insulated district heating station.

**Building automation system (BAS):** currently the buildings have no BAS; each building and installation is controlled individually by numerous, mostly analog, detached control systems (i.e., at the district heating station, the DHW storage, the exhaust air ventilation system).

In the EPC project, a BAS will be installed to connect all buildings, measurements, meters, and installations in an open BACnet system. The BAS will include energy commissioning functionality. This will allow monitoring of all major installations: operation parameters such as temperature and pressure; malfunctions; energy consumption; etc. The status will be presented graphically, and the BAS will generate performance evaluation metrics that will enable the ESCO immediately to evaluate energy and operation parameters on an hourly, daily, monthly, and annual level.

The BAS will have three hierarchies: (1) the BAS and data management system with external remote control options; (2) the substations on the building level with some 20 – 30 data points each; and (3) the local metering and control gear, such as temperature sensors, pressure sensors, etc. (Figure A-9).

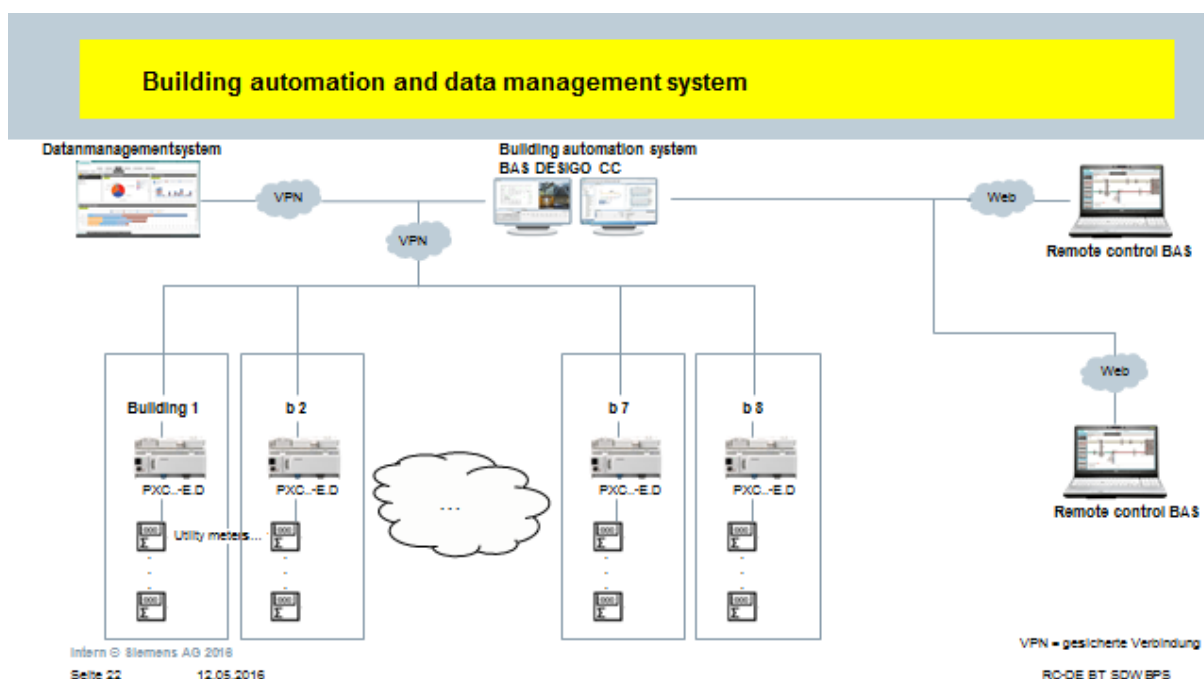

Figure A-9. Ludwig Frank Quartier BAS scheme.

### A.14. Energy consumption

Table A-1 to A-3 summarize Ludwig Frank Quartier baselines and benchmarks.

Table A-1 lists pre-renovation energy use (total and per m<sup>2</sup>/year).

Table A-1. Ludwig Frank Quartier heating baseline and benchmarks.

Heating (district heating) for the Eight Buildings					
Baseline climate adjusted [kWh/yr]	Baseline price [€/kWh]	Load [kW/yr]	Load [€/kW]	Fixed price [€/yr]	Cost baseline [€/yr]
2,563,320	0.0459	469	106.21	1020.87	168,489.74
EUIHeat: depending on the building: 78 – 131 kWh/m <sup>2</sup> yr (24.7 – 41.5 kBtu/ft <sup>2</sup> )					
CUIHeat: depending on the building: 4.97 – 12.6 €/m <sup>2</sup> yr (0.45 – 1.14 €/ft <sup>2</sup> yr)					

Table A-2. Ludwig Frank Quartier power baseline and benchmarks.

Electric Power for the eight Buildings						
Baseline HT [kWh/yr]	Baseline NT [kWh/yr]	Baseline total [kWh/yr]	Baseline price HT [€/kWh]	Baseline price NT [€/kWh]	Fixed price components [€/yr]	Cost baseline [€/yr]
299,598	313,577	613,175	0.1911	0.1398	9225.2	109,484
EUIPower: depending on the building: 17.8 – 31.3 kWh/m <sup>2</sup> yr (5.6 – 9.9 kBtu/ft <sup>2</sup> ) CUIHeat: depending on the building: 3.1 – 5.6 €/m <sup>2</sup> yr/ 0.28 – 0.51 €/ft <sup>2</sup> yr						

Table A-3. Global cost baseline Ludwig Frank Quartier.

	Heating	Power	Water/Sewage	Total
Global Cost Baseline	168,530.60 €	107,881.95 €	169,963.72 €	446,376.27 €

### A.15. Predicted energy savings

Table A-4 lists predicted energy savings for the Ludwig Frank Quartier.

Table A-4. Predicted energy savings.

Total savings	Savings kWh/yr	Savings in %
Heating	470,200	19%
Electricity	205,265	36%
Water (m <sup>3</sup> /yr)	14,159	34%

### A.16. Measured energy savings

Renovation not yet complete.

### A.17. Renovation costs and avoided energy costs

The bundling of ECMs and ESMs can increase the cost effectiveness of a DER EPC significantly and thereby reduce the investment and performance risks for the ESCOs. In the Ludwig Frank Quartier, the combination of HVAC measures and PV in seven buildings and the CHP and a DER in one building will provide a payback period of 17.4 years (simple or static payback of 13.8 years) to the global investment costs, without any seed money. Table A-5 lists and Figure A-10 shows the cumulative impacts of these measures on the payback.

Table A-5. Cost optimization of the DER EPC project at Ludwig Frank Quartier.

	Investment k€ (€/m <sup>2</sup> ) (€/ft <sup>2</sup> )	Energy Savings	Energy Cost savings (k€/m <sup>2</sup> yr) (k€/ft <sup>2</sup> yr)	Cumulative Static Payback (yrs)
<b>B 42 DER envelope, ventilation, HVAC, lighting</b>	982 T€ (263 €/m <sup>2</sup> ) (24.5 €/ft <sup>2</sup> )	57% 54% heating 3% power	11.5 k€ (3 €/m <sup>2</sup> yr) (0.28 €/ft <sup>2</sup> yr)	91
<b>B2 HVAC, lighting, PV</b>	118 T€ (36 €/m <sup>2</sup> ) (3.35 €/ft <sup>2</sup> )	43% 10% heating 33% power	4.5 k€ (1.5 €/m <sup>2</sup> yr) (0.14 €/ft <sup>2</sup> yr)	75
<b>B3 HVAC, lighting, PV</b>	118 T€ (35 €/m <sup>2</sup> ) (3.26 €/ft <sup>2</sup> )	26% 10% heating 16% power	6.1 k€ (2.1 €/m <sup>2</sup> yr) (0.19 €/ft <sup>2</sup> yr)	61
<b>B4 HVAC, lighting, PV</b>	115 T€ (35 €/m <sup>2</sup> ) (3.07 €/ft <sup>2</sup> )	31% 10% heating 21% power	5.1 k€ (1.8 €/m <sup>2</sup> yr) (0.16 €/ft <sup>2</sup> yr)	55
<b>B5 HVAC, lighting, PV</b>	105 T€ (33 €/m <sup>2</sup> ) (3.07 €/ft <sup>2</sup> )	46% 10% heating 36% power	15.1 k€ (5.2 €/m <sup>2</sup> yr) (0.48 €/ft <sup>2</sup> yr)	40
<b>B6 HVAC, lighting, PV</b>	119 T€ (38 €/m <sup>2</sup> ) (3.5 €/ft <sup>2</sup> )	41% 15% heating 26% power	11.2 k€ (3.8 €/m <sup>2</sup> yr) (0.35 €/ft <sup>2</sup> yr)	35
<b>B7 HVAC, lighting, PV</b>	120 T€ (38 €/m <sup>2</sup> ) (3.5 €/ft <sup>2</sup> )	53% 15% heating 38% power	12.7 k€ (4.0 €/m <sup>2</sup> yr) (0.37 €/ft <sup>2</sup> yr)	31
<b>B8 HVAC, lighting, PV</b>	115 T€ (35 €/m <sup>2</sup> ) (3.26 €/ft <sup>2</sup> )	56% 15% heating 41% power	6.6 k€ (2.2 €/m <sup>2</sup> yr) (0.21 €/ft <sup>2</sup> yr)	31
<b>Buildings 1-8 supply solution CHP, Gas peak boiler,</b>	+749k€ (28 €/m <sup>2</sup> ) (2.6 €/ft <sup>2</sup> )		113 k€/yr (4.2 €/m <sup>2</sup> yr) (0.39 €/ft <sup>2</sup> yr)	20
<b>TOTAL</b>	2.541k€ (93.1 €/m <sup>2</sup> ) (8.5 €/ft <sup>2</sup> )		185.8 k€ (7.2€/m <sup>2</sup> yr) (0.67€/ft <sup>2</sup> yr)	
<b>Partition of avoided maintenance and refurbishment to achieve 17 years dynamic payback</b>			44 T€/yr (1.6 €/m <sup>2</sup> )	13.8 yrs (static payback)

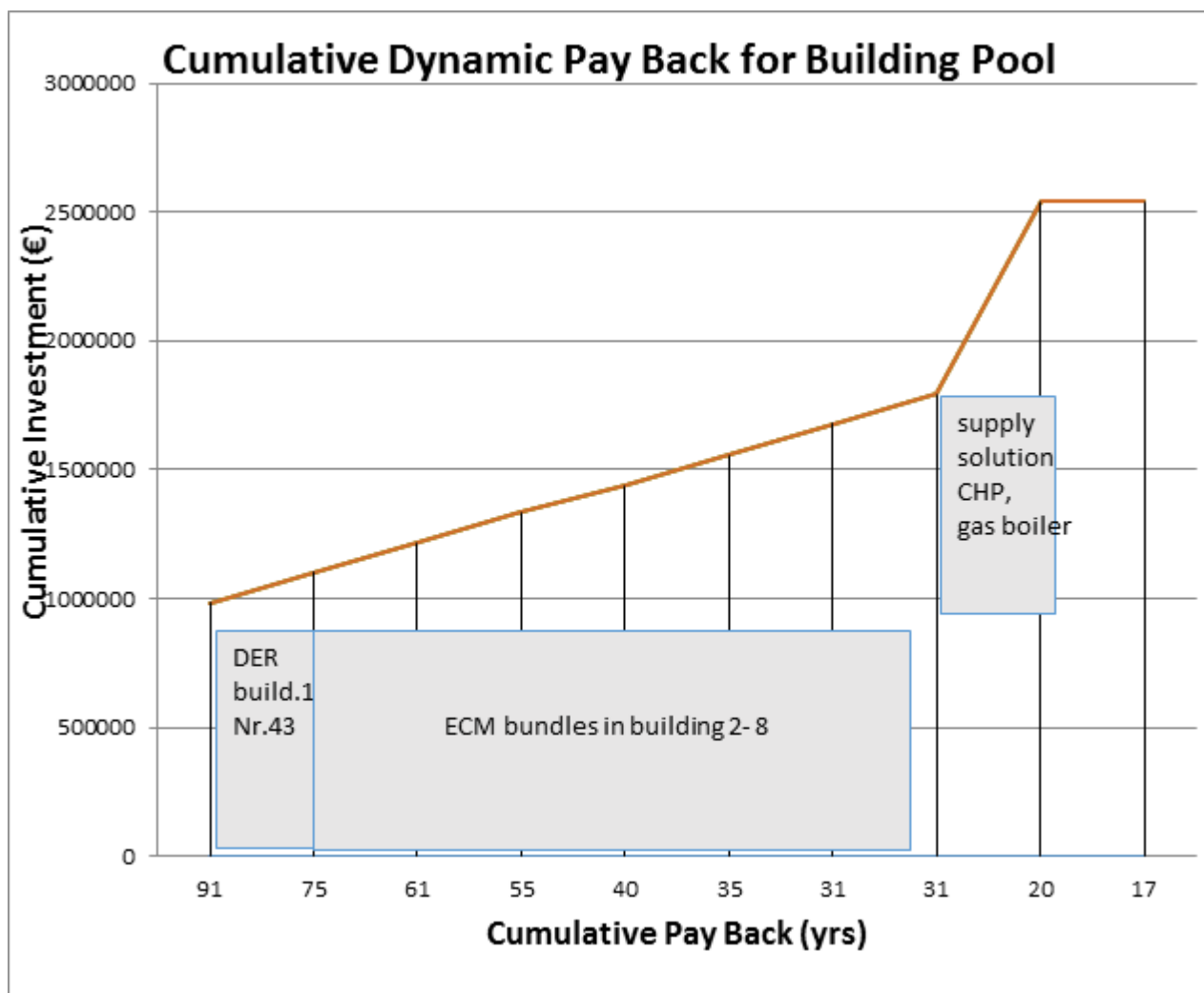

Figure A-10. Cumulative payback.

## A.18. Business models and funding sources

### Decision-making process criteria for funding and business models

Because the building owner, SWMA, has a limited investment budget, it decided to provide the estimated investment of approximately €3 million using a public-private-partnership. Due to the strict debt limit policies for public entities; several options were considered with regard to the parties involved; their commitment; and responsibilities, funding, remuneration, and relevance for debt, leasing, Public-Private Partnership (PPP) with rental remuneration, and EPC. SWMA had experienced a “lost investment” in a recent DER project; therefore the reliability of the business model and a debt-neutral approach were their major decision-making criteria. EPC puts the ESCO in the role to invest, finance, implement, and operate the ECM bundle. EPC provides a performance-related remuneration scheme for the building owner (“pay as you save”), which can be considered debt-neutral from the perspective of public accountancy regulations in Germany.<sup>4</sup> However EPC so far had only been considered for HVAC measures. Integrating the building envelope into an EPC project meant

<sup>4</sup> “Debt- neutral regulation of EPC in the German Federal sector,” Berlin Senate, 2008 at <http://www.kompetenzzentrum-contracting.de/praxishilfen/laenderregelungen-haushaltsrecht/berlin> (GERMAN)



tripling the investment budget compared to a “typical” HVAC EPC. Also the ESCOs had no experience in how to deploy building envelope ECMs and guarantee their performance.

A successful business model for DER projects defines the elementary formulations on how to generate customer satisfaction by accomplishing what is required to complete energy efficiency measures for the building, and at the same time by gaining additional value related to improvements in the building envelope and other non-energy-related benefits such as added construction value and improved indoor comfort.

The three business models have been assessed with regard to how the objectives of SWMA, the building owners, or likewise any other financier or investor are considered in terms of the energy and costs savings reliability and the investment costs. How does the design of the responsibilities, services and financial streams between these parties support the reliability of these outcomes in the common regulatory structures currently in use in Austria and Germany such as standard contracts between architects, planners, building owners,<sup>5</sup> and ESCOs?<sup>6</sup>

One of the crucial criteria is the reliability of outcomes.<sup>7</sup> These are summarized under the following sub-criteria. The rating (Table A-6) of these criteria is based on a telephone interview questionnaire of 19 commercial and private building owners and funding entities with experience in business models (Figure A-11) in Germany and Austria, plus the SWMA.

- a. Reliability of investment and planning costs: For making an investment decision and any financing decision, a reliable investment cost calculation is essential. The investment and planning costs are usually collected by the architects and planners. The precision of this estimation is related to commercial and scientific databases. As in DER projects, not many evaluated projects<sup>8</sup> are available, so the experience of the planners and architects involved is the major criterion. To what degree do incentives exist that motivate parties involved to keep existing investment and planning cost limitations or to agree on flat rate or turn-key cost agreements?
- b. Reliability and impact of energy and LCC performance: The payback from DER investments impacts the building owner’s cash flow. Appropriate funding requires an internal return on investment; external funding requires annuity costs. To achieve a “cost-neutral” cash flow, the energy and LCC performance must balance the cash flow within a predicted time period. The common regulatory framework of the business model is assessed to determine the funding method that best supports meeting these criteria.
- c. Bankability of cost benefits: the criteria defined under a) and b) are assessed with regard to their bankability. With the requirements for appropriate capital

---

5 Honorarordnung Architekten und Ingenieure HOAI 2013, Bundesministerium für Justiz, Berlin, Deutschland, HOA AU Austria, BIK Verlag, Wien, 2002;

6 Standard Contract for EPC, EESI European Energy Service Initiative at <http://www.european-energy-service-initiative.net/eu/toolbox/eurocontract-toolbox.html>

7 EEFIG Final report, Feb. 2015, Brussels at <https://ec.europa.eu/energy/en/news/new-report-boosting-finance-energy-efficiency-investments-buildings-industry-and-smes>

8 Report on the analysis of DER projects accomplished, IEA Annex 61, 2016 at [www.iea-annex61.org](http://www.iea-annex61.org)

ratios, a “debt-neutral” approach creates certain requirements for commercial and (in some EU countries also for) public building owners. One example is the legal note of Eurostat, which requires that, for a debt-neutral approach, the savings must be guaranteed and that the investment costs equate to at least 50% of the current asset value of the building. To assess the bankability, it is also considered to what extent the cost/benefits could be forfeited<sup>9</sup> and traded among financing institutions. The regulatory framework of the business models is assessed with regard to the bankability of the cost/benefits created in a DER project.

- d. Cost effectiveness: the cost effectiveness is defined by the savings per € investment; the business models are assessed with regard to the support they provide to improve this ratio. On the cost side, investment and interest rate costs are considered. These are compared on the side of the savings with average values for avoided energy, maintenance, and other LCC.

Table A-6. Rating criteria for the evaluation of reliability of business models.

	0-3	4-7	8-10
<b>Contracts between building owner and “APCs” (architects, planners and contractors) provide incentives in which level to optimize the criterion</b>	Regulations do not support directly or indirectly the building owner to hand over the responsibility for the criterion	Regulations support indirectly the building owner in handing over the responsibility for the criterion	Strong support to hand over the responsibility for the criterion
<b>Remuneration model between building owner and “APCs” are creating incentives to follow the criterion</b>	Payment is not related to the achievement of the criterion	Payment regulation is only indirectly related to the degree the criterion is achieved	Payment regulation is directly taking into account to which degree the criterion is achieved
<b>Services are provided to support the criterion</b>	Services are not provided to support	Services are provided but only to a certain degree supporting the criterion	Services are provided targeting to support the criterion

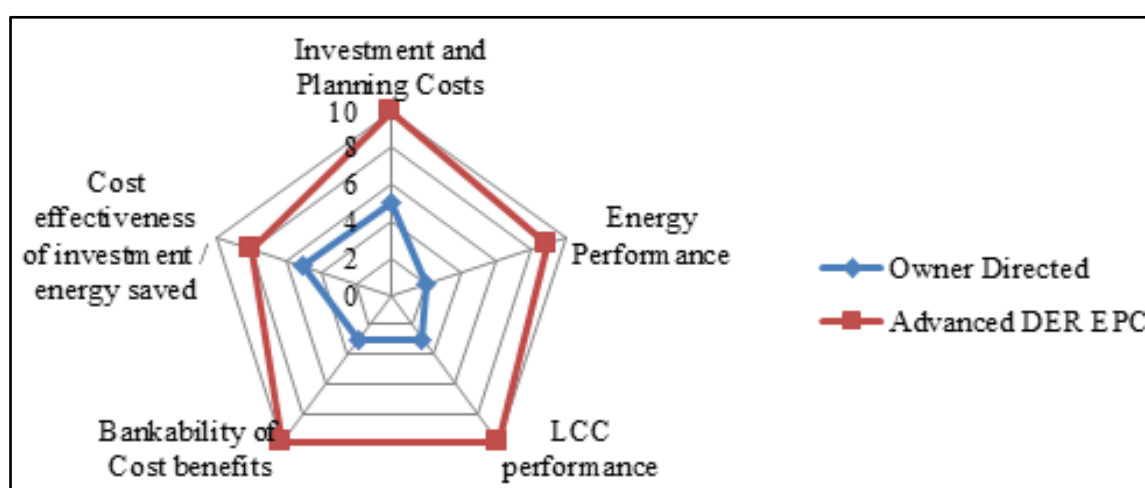

Figure A-11. SWOT analysis of reliability criteria of business models.

The SWMA decided to implement the DER project within an EPC for the following main reasons:<sup>10</sup>

- EPC business models provide significantly better reliability of predictions and improved bankability.
- EPC business models provide better cost effectiveness.

### **Description of the funding sources chosen**

The target of the project is to carry out the DER concept in combination with a performance guarantee and a remuneration system related to the verified performance of the implemented project measures. To better understand the need for “de-risking,” a short review of the EPC business model incorporated in German, French, and many UK EPC contract stipulations is:

- Typically, the ESCO provides planning, modeling, savings calculations, installation, commissioning, and accounting.
- The ESCO guarantees the savings and agrees to provide the M&V after 1 year by comparing baseline consumption with adjusted metered data. This will be checked by the building owner or a neutral third party expert.
- The remuneration of the ESCO is 100% related to the savings performance of the ESCO. In rare cases, the savings performance payment is replaced by a remuneration based on a fixed payment (for example, for measures with a minor impact on the total savings).
- The German contracting schemes reflect international standards provided by the IMVP<sup>11</sup> in major parts.

DER EPC that includes the holistic refurbishment of a building envelope has not been carried out in Germany to date. During the working phase of the German IEA Annex 61 Subtask B working group, three workshops were organized with the ESCO association VfW (German Association of Heating Suppliers, Chapter EPC; [www.vfw.de](http://www.vfw.de)) and four interested ESCOs. This discussion revealed that most of the ESCOs were not interested in DER processes for multiple reasons, including the following:

- Lack of DER reference data: The number of accomplished DER projects that have been evaluated is very small. IEA Annex 61 collected data of more than 26 executed DER projects in representative buildings in PPP or “business as usual” projects conducted by the building owner. The collected investment, planning, and performance data have given insight on the minimum requirements for QA in the modeling process and the risks that the building user’s behavior may have on the performance of the ECMs.
- DER is not a part of the portfolio of typical German ESCOs. Most of the German ESCOs have their core business in BASs and, to some extent, also in HVAC measures. In the Federal state of Baden-Württemberg, the energy agency KEA has, in the last 10 years, conducted some research and project-related efforts to extend the technical scope of the ESCOs according to the needs of commercial and public

---

<sup>10</sup> Executive paper presented October 2015 at SW MA, Mannheim (German, no further source)

<sup>11</sup> International Performance Monitoring and Verification Protocol, IPMVP, at [www.evo-world.com](http://www.evo-world.com)

building owners. On this regional level. ESCOs have had positive experiences with including CHP, biomass boilers, and non-energetic refurbishment measures in EPC projects. ESCOs and KEA have developed numerous adjustments of the national standard contracts as well as project and procurement structures that enabled being able to apply EPC to more projects in the context of the Energy Performance of Buildings Directive (EPBD)<sup>12</sup> and consistent with individual requirements of the building owners. As a reward for these efforts, KEA (the author of this case study) was awarded the European Energy Service Award<sup>13</sup> in 2009.

- Confidence and reliability on both sides: With support and funding of the Ministry of Energy and Environment (MoEE), KEA founded the Contracting Competence Centre Baden-Württemberg in 2015. The main objectives were to create market confidence, to increase the demand side of the market, and to improve the technical scope of EPCs. The contracting competence Centre promoted developing the EPC together with inputs from stakeholders – ESCOs, building owners, and financiers – with regard to the “affordable” risks.
- Financing conditions: ESCOs usually do not use their own resources to finance EPC projects. Most of them use regional banks to refinance their investments. The six major ESCOs providing EPCs on the German market use 10 experienced regional banks to refinance their investments. Financing schemes and business models for DER EPCs have to consider that refinancing for ESCOs is based on the experience these banks have had in recent years with HVAC EPCs. From this perspective, ESCOs will have difficulty refinancing with fixed loan interest rates and contract periods of more than 15 years. Alternative re-funding sources, such as efficiency or green funds or cooperative funds, are not yet prepared to provide financing for ESCOs.
- Maintenance and refurbishment: Usually EPC contracts see the ESCOs in the role of providing availability and ensuring operability by maintaining and even replacing their ECMs in the case of malfunction or equipment/material failure. Almost no experience record is available for extended contract periods beyond 15 years with regard to such risks. Obviously the need for replacement of some parts of the BAS, heating pumps, and speed controls (with designed service lifetime of less than 10 years) becomes much more likely with longer contract periods.
- Performance guarantee: Remuneration of the ESCOs is related to the fulfillment of the energy savings performance guarantees they provide. With regard to the increased likelihood of changing usage parameters in longer contract periods, the costs for the calibration and adjustment of usage parameters in the M&V process increases.

**Technical specification:** The technical specification should provide all necessary information to limit the extent that ESCOs must estimate or calculate. However the specification should invite the ESCO to provide its own ideas in the bidding process. Hence a functional specification is provided with a description of the boundaries, interfaces, and the technical functionality. The design, color, and shape of the external walls; the window partition, color, and measures of the frame, etc. are described in detail to avoid any misinterpretation. In addition, the functional specification also provides:

---

<sup>12</sup> <http://www.buildup.eu/en/practices/publications/2016-implementing-epbd-featuring-country-reports-0>

<sup>13</sup> European Energy Service Initiative EESI at [www.eesi.org/](http://www.eesi.org/)

- Definition of minimum requirements for the building U-values with reference to the KfW<sup>14</sup> standards KfW 100 (which equates to the energetic quality of a new building).
- Definition of minimum HVAC measures: As many of the existing installation such as the district heating stations, the control systems, etc., are at the end of their lifetime, the building owner usually requires a full replacement of these components in the technical specification.

**Transparent tendering process:** Based on the experience of EPC projects with a high complexity (i.e., integration of biomass and infrastructure measures) the DER EPC tendering process should be conducted in three stages:

- Selection of approximately three ESCOs with experience in ECMs for the thermal building envelope and with experience in the use of modeling tools on at least a monthly basis.
- Tendering, negotiation, and EPC contract award: The selected ESCOs receive the contract and process documents, including the baseline and the functional specification, and create their technical concept and commercial bid. Both will be presented in two negotiations. Afterwards, the decision will be made and one ESCO will receive the award. (The Mannheim project was at this stage in (June 2016.)
- Detailed planning phase: The ESCO awarded the contract will prepare a detailed technical plan (together with SWMA). The QA of the technical planning will be provided by external experts with expertise in DER and building physics. After agreeing on the detailed plan, the implementation phase for the Mannheim project started in September 2016.

### **A.19. Cost effectiveness of energy part of the project**

See Sections A.15 and A.18.

### **A.20. Experiences/lessons learned**

The facilitation of the first German DER EPC has provided significant progress in terms of the evolution of EPC from an instrument dedicated to picking “low hanging fruits” into a sustainable vehicle that is ready to contribute to implementing the European legislation (EBPD) and the national implementation strategies. The following conclusions may be drawn from this DER EPC case study:

1. The market development for DER EPCs must be carried out as a joint effort of building owners, ESCOs, facilitators, financiers, and experts from the technical side. It was necessary to support these parties, as this was their first experience of working together for project preparation.
2. In preparing the standard contracts, one must carefully assess project development and implementation structures, award criteria, tendering processes, and the DER process to mitigate the risks. Specific investment costs of a DER measures bundle will often be two or three times higher than “normal” or typical HVAC ECMs. This will result in extended payback and EPC contract periods.

---

<sup>14</sup> Kreditanstalt für Wiederaufbau, KfW, Frankfurt, Germany

3. With the risk and responsibility allocation, which can be found in most of the European standard EPC contracts, a longer contract period will lead to an escalation of risks:
  - Maintenance and replacement costs for the building automation, heating pumps, motors, CHP units, and heat pumps will increase.
  - The financing costs (e.g., interest rates) will increase or will, at least, be more difficult to predict.
  - The monitoring and verification will become even more complex as changes of utilization and floor space become more likely over long contract periods.
4. In reference to the concerns of ESCOs, building owners, and financiers, one of the major objectives must be to mitigate the risks arising from longer contract periods. The present DER EPC case study has collected experience with the following key measures:
  - Integrate additional life cycle cost/benefits to reduce the payback and contract period. In this case study, these are avoided maintenance and replacement costs for the existing equipment and construction that will be refurbished by the ESCO. This approach added another 25 – 30% to the energy savings.
  - Optimize re-financing for ESCOs by providing long-term refinancing sources with stable interest rates, such as energy cooperatives or green funds. If a critical investment cost level can be reached, DER EPCs would be eligible for pension funds.
  - Optimize the investment cost/benefit ratio by assembling a building pool with short-, mid- and long-term payback periods. The Mannheim case shows that it is important to give priority to cost/benefit-optimized DER measures and consider the high-efficiency supply solutions second. In this project, PV and CHP power production contribute strongly to the cost effectiveness.
5. Award criteria: The modification of normal EPC award criteria to give a monetary value to sustainable technical concepts (Table A-7) can improve the cost effectiveness discussion in certain areas. In this case, the ESCO provided a bid in which the overall U-value is 15% better than the minimum requirements. The award criteria (to evaluate the ESCO bid) allowed increasing the amount of credit points for this result. Compared to the impact of the other rating and award criteria, this additional rating equates to 2% of the savings criterion. The additional energy savings resulting from the better U-value covers the additional capital costs of the related additional investments for DER. From the perspective of the building owner, there is added value from a better U-value or a more resilient mechanical system; this is provided over the building's anticipated service life in the form of lower maintenance and replacement costs.

The necessary adjustments resulting from this analysis have been documented as a set of de-risking measures (DRMs) in a revised version of the German EPC contract and project structure templates. This is considered to be a first step. Follow-ups will be necessary after the first and second implementation phase are concluded, and after the first year of performance and the results of the first M&V process. Meanwhile, the project team will work on the refinancing sources for ESCOs; this is seen to be a crucial factor for the future success of DER EPCs.

Table A-7. Award criteria of business as usual EPC and DER EPC Mannheim.

	<b>German EPC (business as usual)</b>	<b>DER EPC</b>
<b>Award criteria for EPC tendering</b>	(1) Net present value of savings in total and remaining with administration 70–80%	(1) Net present value of savings in total and net present value (NPV) of the partition of the savings remaining with building owner 50%
	(2) Contract period 10–20%	(2) Sustainable measures and concept 40%
	(3) Carbon Footprint 10–20%	(3) Carbon Footprint 10%
<b>Additional terms</b>	—	Avoided maintenance costs for the replacement of existing installations are part of the savings

## Appendix B: IWU Office Building, Darmstadt, Germany

### B.1. Name of project, location

Institute Wohnen und Umwelt (IWU) Office Building, Darmstadt, Germany.

This case study describes a DER renovation of a representative 1960 office building in Darmstadt, Germany, which was carried out 2012 – 2013.

### B.2. Description of the building, installations and usage pre-refurbishment

The German building modeled (Figure B-1) is an existing office building in Darmstadt, Germany. The building is composed of prefabricated large concrete panel elements, a typical building and construction in Germany from the period 1960-80. Before the refurbishment all necessary data of the existing building were collected in an on-site assessment (Table B-1).



Figure B-1. Front view from the street on the southern part of the building before refurbishment (Darmstadt case study).

Table B-1. Characterization of the IWU Darmstadt modeling case study.

Number of floors	3
Net area	1,680 m <sup>2</sup> , (18,083 ft <sup>2</sup> )
Heated area	1,680 m <sup>2</sup> , (18,083 ft <sup>2</sup> )
Number of zones	10
Compactness: Building envelope/volume	0.38
Building usage	Office (8 am – 7 pm), 5days/week



### Ventilation system

The restrooms of the building were equipped with three exhaust air systems (3,000 m<sup>3</sup>/hr/ 3,900 m<sup>3</sup>/hr and 5,000 m<sup>3</sup>/hr, which is 10,596 ft<sup>3</sup>/hr; 13,772 ft<sup>3</sup>/hr and 17,657 ft<sup>3</sup>/hr), constant air flow, with an electrical load for the fans in total 8 kW (27.4 kBtu/hr) operating 8,000 hours/year. The three restroom areas and the street side office rooms on each floor were connected by a vertical concrete exhaust air from basement to rooftop. In the office areas, windows could be opened for fresh air. Together with the leakage rate of the building, adequate air quality was achieved. The indoor climate conditions required by German building codes did not require additional air-conditioning and cooling systems. Cooling was only installed in the IT server room.

### Heating and heating distribution

The building was heated by two gas boilers installed in 1992 with a capacity of 500 kW (1,706 kBtu/hr) each. The boilers were used for both heating and DHW. The hot water temperature was controlled by an outdoor temperature-based control system with a maximum heating temperature of 90 °C (194 °F) at the assumed minimum outdoor temperature of -12 °C (10.4 °F) in that climate zone. The circulation pumps were operated at constant speed.

The heating distribution was through steel pipes distributed in a duct system in four building zones. Steel radiators equipped with thermostats allowed for individual control of each zone. The insulation was mineral wool dimensioned at ¼ of the pipe diameter.

### Domestic hot water

The existing DHW used a centralized system with the boiler as a heating source at a constant temperature of 70 °C (158 °F). German building codes require at least once a week that the temperature be raised above 70 °C (158 °F) to meet minimum hygienic requirements. However, in most of the buildings, this temperature is permanent. The DHW is distributed in two steel distribution pipe systems: one is responsible for the transport of the DHW and the second provides the minimum circulation of DHW for hygienic purposes and the first response on DHW demand. 18% of fuel site energy was required for DHW.

### Lighting system

The building was primarily equipped with white-reflector T8 fluorescent lamps with 15 W/m<sup>2</sup> (1.4 W/ft<sup>2</sup>) average in office spaces, 10 W/m<sup>2</sup> (0.82 W/ft<sup>2</sup>) average in floor space.

### Construction

The thermal transmittances of the building envelope were:

External walls 1,310 m<sup>2</sup>  $U_{\text{wall}} \approx 1.36 \text{ W/m}^2\cdot\text{K}$ , (0.24 Btu/h ft<sup>2</sup> °F)

Roof-ceilings 692 m<sup>2</sup>  $U_{\text{roof}} \approx 0.7 \text{ W/m}^2\cdot\text{K}$ ; (0.12 Btu/h ft<sup>2</sup> °F)

Windows 352 m<sup>2</sup>  $U_{\text{window}} \approx 3.3 \text{ W/m}^2\cdot\text{K}$ ; (0.58 Btu/h ft<sup>2</sup> °F)

Basement 620m<sup>2</sup>  $U_{\text{basement}} \approx 0.52 \text{ W/m}^2\cdot\text{K}$ ; (0.09 Btu/h ft<sup>2</sup> °F)

The building envelope contained multiple structural thermal bridges (jalousie niches, etc.).

### B.3. Description of the cost-optimized DER bundle

Before starting the refurbishment process, the energy performance of different reference scenarios was simulated by using the energy and indoor climate simulation program PHPP. This software is meticulously validated and allows the modeling of internal and solar loads and of outdoor climate and HVAC systems.

The German Test Reference Year (ASHRAE Climate Zone 5, Würzburg) is used for outdoor climate conditions (design temperature for heating measures is -15 °C [5 °F]).

The project was carried out as described in Scenario 4 (Passive House). In preparation for the refurbishment project, a detailed energy audit of the building was made; this is documented in the “baseline scenario.” For this modeling approach different scenarios were assessed:

- Scenario 1 with the basic requirements of German building code for existing buildings.
- Scenario 6 to approach “-50% of baseline,”
- Scenarios 2, 3, 4 and 5 targeting more than 70% of savings using different DER measures bundles.

The modeling was carried out with PHPP,<sup>15</sup> which provides a monthly site and source energy balance calculation in Excel format and is mostly used for the certification of low energy and nearly NZE buildings (NZEbs) in Germany.

One of the research targets in this modeling effort was to improve the accuracy of the modeling process. Findings from the assessment of eight accomplished DER projects<sup>16</sup> show that, in more than 50% of cases, the predicted performance of the modeling process is actually not met; in more than 40% of cases, the actual energy use exceeds the predictions by more than 10%.

In most of the modeling processes, the information loop between the modeling and the actual performance is not closed. This is even the case in existing buildings where a back calibration using actual performance data of the pre-refurbishment status is not carried out. The effect has been described by IWU<sup>17</sup> in the “Modeling Rebound and Prebound Effect.” Also in this modeling process, the rebound effect has been assessed: by setting up the modeling using the building construction and the U-values, air leakage, internal gains, and usage data the calculated baseline is more than 30% higher than the actual measured and climate-adjusted baseline consumption reflected in the utility bills. Since the building has already been refurbished, a second back calibration of the modeling was carried out using the actual performance of the building from the implemented Scenario #4.

The back calibration was carried out as an iterative process using the following

---

<sup>15</sup> PHPP: Passive House Planning Tool, PHI, Darmstadt 2010-2015

<sup>16</sup> Assessment of 8 accomplished DER projects in 8 German public buildings, EDLIG, 2014 (German)

<sup>17</sup> Prebound und Rebound in der energetischen Modellierung, IWU Darmstadt, 2013 (German)

parameters until the measured and climate-adjusted consumption before and after the refurbishment were exactly as depicted in the modeling tool:

- Usage parameters: Reduction of the hours of usage in office space zones.
  - Indoor temperature profiles: the assumed indoor temperature for the usage time of office spaces had to be reduced in accordance with the reduced hours of usage. In the modeling calculation, two temperature profiles are assumed: the “in use” temperature profile in the office space of 21 °C (69.8 °F) and the “standby,” which is set at 18 °C (64.4 °F). To calibrate the model the “standby” and “in use” temperature, profiles for the office zone had to be reduced as well as the hours per day in which the “in use” temperature profiles were used.
  - Internal loads: The assumptions for the internal heating loads had to be increased. They are considered to be 24 hours a day and 2.3 W/m<sup>2</sup> (0.73 Btu/h-ft<sup>2</sup>). The internal loads reduce the heating demand during the heating season. The heating season is considered to be 212 days/yr for highly isolated scenarios and 365 days/yr for the pre-refurbished building. The heating period of the well-insulated Passive House is much shorter than in the less insulated buildings. The internal gains are only taken into account during the heating period, depending on the insulation level of the building.
  - Ventilation airflow is assumed to be 0.365 1/hr (0.013 ft<sup>3</sup>/hr) for the renovated building.
  - Target indoor temperature: 20 °C (68 °F) in office spaces and hallways.
  - Indoor temperature in summer: 25 °C (77 °F).
  - Internal heat gains from building users: 1.26 W/m<sup>2</sup> (0.40 Btu/hr-ft<sup>2</sup>).
  - DHW consumption was not separately metered in the pre-refurbished building and had to be estimated at 10 l (2.6 gal) per capita per day. With regard to areas of minimal consumption, high losses were addressed by replacing the DHW distribution system with detached small instantaneous electric water heaters.
- The usage of heating energy (site energy) and electricity (site energy) for different refurbishment scenarios takes into account the energy for space heating, ventilation, DHW, all electricity (including lighting and appliances – plug loads), and energy losses.

### Economic modeling

The drivers of a decision-making process for a building that has reached the end of its life cycle are mostly related to the future purpose of the building, and do not consider the energetic options in the first step. German building codes allow “maintenance refurbishments” if only minor construction measures are applied. Maintenance refurbishments include concrete refurbishments, partial replacement of HVAC components, painting, etc. In comparison, a major repurposing that requires major construction measures of the building envelope and in the building floor space must adhere to the minimum energetic requirements of the German Energy-Saving Ordinance (EnEV<sup>18</sup>); this is Scenario 1 of the modeling scenarios. However, a major repurposing concept also has to be considered a once-in-a-life cycle opportunity to enhance the energetic quality of the building beyond the minimum requirements. The

---

<sup>18</sup> Energieeinsparverordnung EnEV 2014, Berlin, 2014 (German)

decision-making process of this modeling project considers choosing among “maintenance refurbishment” and other scenarios of energetic refurbishment.

- Investment cost databases: The investment costs (Table B-2) were taken from refurbishment cost databases and cost data collected from the implemented refurbishment of this specific building (Scenario 4). The databases distinguish between different measures in construction and HVAC and consider the total specific costs per m<sup>2</sup>, including costs for the equipment, labor and the VAT of 19%. However these data for other scenarios should only be considered as average estimated values, as the cost elements vary by the month of implementation and the region in which the project is located. Investment costs for the other modeling scenarios are taken from different databases of evaluated refurbishment costs: Passive House Institute, 2008/14 contains data from the accounted investment costs of numerous implemented refurbishment projects documented by the Passive House Institute for both residential and non-residential buildings. The Scenario 3 investment costs have been taken from a recently completed tendering process. In 2014, the refurbishment costs for projects carried out in the Federal building stock were collected in BBSR, 06/2014.
- Within the German research project EDLIG (energy services for deep refurbishments), KEA collected and evaluated at least 15 different projects' investment costs (KEA/ EDLIG evaluation 2014). In general, collecting reliable investment data is labor-intensive, as there are only a few published evaluation reports available. There is a need for additional research, to compile estimated and verified investment costs for all important building types.
- The investment costs are provided on the single ECM level. The cost-cutting effects of bundling measures and of carrying out a multi-measure project in one stage are not yet depicted in cost databases. In this case, the actual cost data for the Scenario 4 bundle were available. A comparison with cost databases from other projects shows that the sum of investment costs of single components averages >20% higher than the actual investment costs incurred when Scenario 4 was implemented.
- For the decision-making process to choose between a maintenance refurbishment and different energetic scenarios, investment costs are classified into measures that are necessary for the maintenance and those additional costs that are necessary to achieve the different energetic scenarios. The “maintenance costs” are painting, plastering, scaffolds, new roof cladding, concrete refurbishments, replacement of technical equipment, etc., but with no energetic improvement. Energetic-related costs are those that save energy in the future, such as the thermal insulation of a wall or roof. In the case of window replacement, it is assumed that this is an energetic improvement.
- Lifetime period of measure bundles: The service life time period has been derived from the averaged individual lifetime periods given for each measure in the German industrial standard VDI 2067 (Table B-2).<sup>19</sup> To calculate the average life time periods for each scenario, the individual life time periods of the considered

---

<sup>19</sup> VDI 2067, Blatt 1, Beuth Verlag, Berlin 1993- 2014

components are weighted by the investment costs of the individual measures in comparison to the total investment of each scenario. To simplify the comparison of the scenarios, an average lifetime period of 33 years is assumed for all scenarios. The economic balance considers the costs and savings over an average period of 33 years. Components with a shorter service lifetime, such as lighting and shading systems, are considered with end of life cycle maintenance costs. A re-investment of components with an average life time period less than 33 years is not considered; neither are residual values of installations with an average lifetime period greater than 33 years. As these installations contain the major part of the investments (70 – 80% in the scenarios), this assumption is disadvantageous to those scenarios implementing high levels of insulation.

Table B-2. Lifetime periods and average maintenance costs according to VDI 2067.

Measure	Lifetime period (years)	Average annual maintenance costs in % of investment costs
Wall insulation	50	0.75%
Windows	30	0.75%
Ventilation systems (unit and ducts)	27	2.5%
Lighting systems	20	3%
Shadings	20	4%

- **Capital costs:** The economic model assumes that the investment is funded 100% by bank loans, with a loan period of 20 years with fixed interest rates. After 20 years, no further loan payments will take place and 100% of the investment and the interest will be paid back. The market offers low interest rates for loans with 15 – 20 year payback periods (but not yet for 33 years). The interest rate chosen was 2.5% (20 years fixed).
- **Energy Savings:** The calculated energy savings of each scenario are valued with a site energy heating price of 0.1 €/kWh (0.04 \$/BTU) and electricity price of 0.29 €/kWh, including energy taxes and VAT of 19% in year one. In the sensitivity analysis, the energy cost savings are calculated with prices increasing at rates of 2 and 4%. After year 20, the measure bundle has a residual value that generates value; the building is still in use until the year 33. All savings are calculated for years 0 – 33.
- **Maintenance cost savings:** The replacement of existing and worn out installations and constructions is accounted for in the LCC analysis. In most of the cases, owners of small- and medium-sized buildings do not track data on maintenance costs appropriately. In this modeling project, the maintenance costs are calculated on the basis of the industrial standard VDI 2067 (reference Table B-2), which provides empirical data for maintenance costs for some of the major construction and HVAC equipment as a percentage of the investment costs of newly installed equipment. These percentage values are considered as average values over the life time period (see above). At the start of the lifetime period, the value is assumed to be 0; in the middle of the lifetime period it equals the average value given in the standard; and at the end of the lifetime period, it is considered to be double this average value. In this modeling approach, 0.5% of

the new investment costs are used for the avoided maintenance costs for the existing wall, roof, windows, and HVAC installation. Additional savings potential from the maintenance avoided by downsizing the HVAC equipment were not accounted for.

- Other potential savings: Other potential savings such as avoided insurance and operation costs were not included.

### Cost/benefit analysis

The economic calculations are focused on a 33-year period of costs and savings, based on calculated investment costs (three scenarios), and verified investment costs from the implemented project (Scenario 4). These investment costs are converted into annual costs by annuities that are based on a discount rate of 2.5% (fixed), no residual value, and a time period of 20 years (Table B-3). For years 20 – 33 only re-investment-related costs appear, and savings are still counted. Other additional costs, such as maintenance and operation of new installations, are not included. The annual savings do include the energy cost savings and avoided maintenance.

The cost/benefit analysis in this study included only investment costs and differences in energy and maintenance costs. Other benefits such as increased building values and increased tenant rates were not considered in the assessment. This assessment method only provided information on which of the measure bundles provide the best cost/benefit. Sensitivity studies with higher energy prices and interest rates should be considered. From the four optional LCC calculation methods (discounted cash flow, annuity-method, dynamic payback period and the NPV), the NPV method was chosen. The NPVs of all annual costs and all cost savings are calculated for today's NPV by using the cumulative discount rates if the difference between the NPVs of savings and costs is positive.

Table B-3. Corner points of the economic modeling of the Darmstadt case study.

Parameter	Unit	Value
Loan payback period n	[years]	20
Life time period $\varnothing$ N	[years]	33
Interest rate/discount rate i	[%]	2.5
Avoided maintenance costs for replaced installations in % of new investment costs	[%/yr]	0.5
Price increasing rates	[%/yr]	0, 2, 4
Energy price district heating	[€/kWh]	0.10
Energy price electricity	[€/kWh]	0.29

Figure B-2 shows the investment costs per m<sup>2</sup> of the total heated floor area, split into maintenance costs and energy-related costs for the different measures. The same amount of maintenance investment costs is considered for all scenarios. The major differences can be found across options of wall and roof insulation, air tightness, and different air ventilation systems. In Scenario 1, no wall insulation is installed, and the other measures are minimal because this is the scenario with the lowest investment

costs. The other scenarios are more expensive because of the more complex measures.

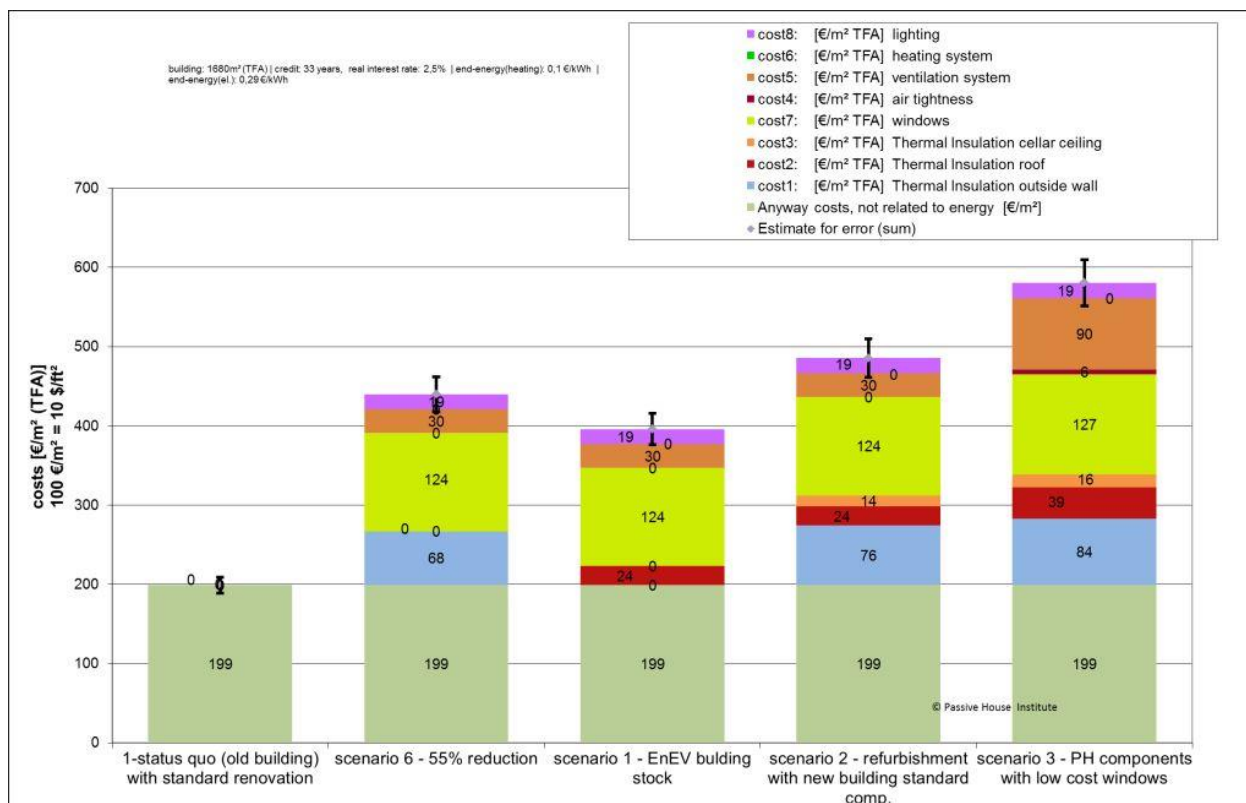

Figure B-2. Specific investment costs of measures and measure bundles of the Darmstadt case study.

### B.4. Description of the modeling scenarios

The plug loads were reduced significantly by replacing old computers and tube screens with energy efficient equipment, installing an energy efficient server, and the complete removal of private coffee-machines, electric kettles and refrigerators in the office rooms. In the modeling calculation, it is assumed that the plug loads in all scenarios are kept the same; only differences in electricity due to lighting, ventilation, DHW supply, and auxiliary electricity were modeled. No cooling load is foreseen, as in all scenarios the minimum requirements for indoor climate conditions (air exchange rate per hour and m<sup>2</sup> and peak indoor temperatures) defined in the building code regulations were achieved. After the refurbishment, the building has been connected to district heating (73% CHP and 27% oil peak load boiler). The data in Tables B-4 and B-5 give a technical description of scenarios of the Darmstadt case study.

#### Scenario 0: Baseline

Energy performances of four different energy-saving scenarios were compared to the building’s pre-refurbishment state (energy consumption, U-values, air leakage rate, and thermal bridges). In the first iterations of the modeling process, the modeled demand of the baseline scenario did not meet the monitored consumption (rebound effect). This was adjusted by modifying the usage and ventilation parameters of the building before refurbishment. The initial calculated specific site energy consumption for heating was 236 kWh/m<sup>2</sup>yr (75 kBtu/ft<sup>2</sup> yr). The electricity consumption (including

plug loads and excluding IT servers) was 20 kWh/ m<sup>2</sup>yr (6.12 kBtu/ft<sup>2</sup> yr). In comparison, the measured and climate-adjusted consumption for heating was 216 kWh/m<sup>2</sup>yr (69 kBtu/ft<sup>2</sup> yr) and the electricity consumption (with plug loads) equated to 20 kWh/m<sup>2</sup>yr (6.12 kBtu/ft<sup>2</sup> yr).

Table B-4. Technical description of scenarios (SI Units) of the Darmstadt case study.

Measure	Baseline (0) old building as built 1962	Scenario 1 EnEV building stock	Scenario 2 EnEV standard for new buildings	Scenario 3 Passive House with low cost PVC window frames	Scenario 4 Passive House (as refurbished)	Scenario 6 55% reduction
Roof ( $\lambda=0.035$ W/m K) insulation thickness / U-value	no improvement	160 mm/ U=0.2 W/m <sup>2</sup> K	160 mm/ U=0.2 W/m <sup>2</sup> K	400 mm/ U=0.085 W/m <sup>2</sup> K	400 mm/ U=0.085 W/m <sup>2</sup> K	no improvement
Wall ( $\lambda=0.032$ W/m K), insulation thickness/ U-value	0	-	140 mm/ U=0.24 W/m <sup>2</sup> K	300 mm/ U=0.11 W/m <sup>2</sup> K	300 mm/ U=0.11 W/m <sup>2</sup> K	60 mm/ U=0.5 W/m <sup>2</sup> K
Basement ceiling	-	-	85 mm/ U=0.3 W/m <sup>2</sup> K	120 mm/ U=0.23 W/m <sup>2</sup> K	120 mm/ U=0.23 W/m <sup>2</sup> K	-
Venetian blind cassette	-	-	-	80 mm	80 mm	-
<b>Windows:</b>						
U-values for glass		U <sub>g</sub> =1.3 W/m <sup>2</sup> K	U <sub>g</sub> =1.3 W/m <sup>2</sup> K	U <sub>g</sub> =0.64 W/m <sup>2</sup> K	U <sub>g</sub> =0.64 W/m <sup>2</sup> K	U <sub>g</sub> =1,3 W/m <sup>2</sup> K
U-values window (average of frame and glass)		U <sub>w</sub> =1.3 W/m <sup>2</sup> K	U <sub>w</sub> =1.3 W/m <sup>2</sup> K	U <sub>w</sub> =0.74 W/m <sup>2</sup> K	U <sub>w</sub> =0.74 W/m <sup>2</sup> K	U <sub>w</sub> =1.3 W/m <sup>2</sup> K
Ventilation	exhaust air system only on street side rooms	exhaust air system	exhaust air system	ventilation with heat recovery	ventilation with heat recovery	exhaust air system
Generation of warm-water	heating boiler					
<b>Lighting system</b>						
Lighting control	Manual	presence detector	presence detector	presence detector	presence detector	presence detector
Natural night ventilation in Summer for cooling		X	X	X	X	X
Cooling system for server	X	X	X	-	-	X
Sun protection		X	X	X	X	X



Table B-5. Technical description of scenarios (I-P Units) of the Darmstadt case study.

	<b>Baseline (0)</b>	<b>Scenario 1</b>	<b>Scenario 2</b>	<b>Scenario 3</b>	<b>Scenario 4</b>	<b>Scenario 6</b>
<b>Measure</b>	<b>old building as built 1962</b>	<b>EnEV building stock</b>	<b>EnEV standard for new buildings</b>	<b>Passive House with low cost PVC window frames</b>	<b>Passive House (as refurbished)</b>	<b>55% reduction</b>
<b>Roof</b> ( $\lambda=0.035$ W/m K) insulation thickness / U-value	no improvement	6.3 in. / U=0.035 Btu/h ft <sup>2</sup> °F	6.3 in. / U=0.035 Btu/h ft <sup>2</sup> °F	15.75 in./ U=0.015 Btu/h ft <sup>2</sup> °F	15.75 in./ U=0.015 Btu/h ft <sup>2</sup> °F	no improvement
<b>Wall</b> ( $\lambda=0.032$ W/m K), insulation thickness/ U-value	0	–	5.51 in. / U=0.042 Btu/h ft <sup>2</sup> °F	11.81 in./ U=0.019 Btu/h ft <sup>2</sup> °F	11.81 in./ U=0.019 Btu/h ft <sup>2</sup> °F	2.36 in./ U=0.088 Btu/h ft <sup>2</sup> °F
<b>Basement ceiling</b>	–	–	3.35 in./ U=0.052 Btu/h ft <sup>2</sup> °F	4.72 in./ U=0.040 Btu/h ft <sup>2</sup> °F	4.72 in./ U=0.040 Btu/h ft <sup>2</sup> °F	–
<b>Venetian blind cassette</b>	–	–	–	3.15 in.	3.15 in.	–
<b>Windows:</b>						
U-values for glass		U <sub>g</sub> =0.229 Btu/h ft <sup>2</sup> °F	U <sub>g</sub> =0.229 Btu/h ft <sup>2</sup> °F	U <sub>g</sub> =0.112 Btu/h ft <sup>2</sup> °F	U <sub>g</sub> =0.112 Btu/h ft <sup>2</sup> °F	U <sub>g</sub> =0.229 Btu/h ft <sup>2</sup> °F
U-values window		U <sub>w</sub> =0.229 Btu/h ft <sup>2</sup> °F	U <sub>w</sub> =0.229 Btu/h ft <sup>2</sup> °F	U <sub>w</sub> =0.130 Btu/h ft <sup>2</sup> °F	U <sub>w</sub> =0.130 Btu/h ft <sup>2</sup> °F	U <sub>w</sub> =0.229 Btu/h ft <sup>2</sup> °F
<b>Ventilation</b>	exhaust air system only on street side rooms	exhaust air system	exhaust air system	ventilation with heat recovery	ventilation with heat recovery	exhaust air system
<b>Generation of warm-water</b>	heating boiler					
<b>Lighting system</b>						
Lighting control	Manual	presence detector	presence detector	presence detector	presence detector	presence detector
Natural night ventilation in Summer for cooling		X	X	X	X	X
Cooling system for server	X	X	X	–	–	X
Sun protection		X	X	X	X	X

### Scenario 1: EnEV building stock – minimum requirements according to the German Energy-Saving Ordinance

The EnEV 2014 (current German Energy-Saving Ordinance) standard for refurbishments in the building stock allows U-values of components to exceed 40% of the standards for new buildings. To design a modeling scenario, the measures were focused on the insulation of the rooftop (160 mm/U-value: 0.2 W/m<sup>2</sup>K/ 6.3 in. / U=0.035 Btu/h ft<sup>2</sup> °F) and the replacement of windows (U<sub>w</sub>= 1.3 W/m<sup>2</sup>K [0.229 Btu/h

ft<sup>2</sup> °F]), which leads to energy savings of nearly 40%. The ventilation of this building is redesigned as an exhaust air system in which the ventilation system transports used air outside the building. The replacement of windows without wall insulation may create thermal bridges at the window slab and is not followed up by thermal wall insulation.<sup>20</sup> Common to all scenarios is the replacement of the centralized boiler for DHW supply by a decentralized, electric flow-type heater.

### **Scenario 2: EnEV new building standard**

This renovation scenario represents the U-value criteria that are required for EnEV 2014 (German Energy-Saving Ordinance) building code. The EnEV targets a low energy standard for new buildings, which is defined by minimum requirements for average U-values  $U_m$  and target values for the source energy demand. To achieve these conditions, wall and basement insulation must be applied. The application of the standard for new buildings already leads to significant heating energy savings of 75% and total site energy savings of 71%.

### **Scenario 3: Passive House with low cost windows**

This renovation scenario represents the criteria for major renovation on the Passive House level, achieving savings of about 86% heating energy. This scenario does not account for new technical solutions but is the cost-optimized version of Scenario 4, the refurbished building in its current status. Scenario 3 takes into account that since 2011 the costs for triple glazed and specifically insulated Passive House windows ( $U_w = 0.74$  W/m<sup>2</sup>K [0.14BTU/hft<sup>2</sup>°F]) has decreased significantly. In Scenarios 3 and 4, a two-duct ventilation system with separated fresh and exhaust air circuits, heating heat exchanger, and a heating recovery system is implemented. In Scenarios 3 and 4, it is assumed that the ventilation system will be used as a standalone installation for heating purposes and may replace the existing radiator-based heating distribution completely. The cost saving effects of closing down the existing radiators and the distribution duct work for heating DHW is, however, not considered in the economic modeling of Scenarios 3 and 4. In both Passive House scenarios, cooling is not needed to achieve the indoor climate conditions required by the building codes.

### **Scenario 4: Passive House (Scenario implemented in 2012)**

This renovation scenario represents the criteria for major renovation on the Passive House and equates the technical concept of Scenario 3. The calculation predicted site energy heating savings of 86%; the actual measured energy savings was 78%.

The decision was to implement Scenario 4.

### **Optimization of bundles**

Optimization of ECMs means finding a minimum total cost, which in this modeling approach is the sum of energy costs, capital costs, and maintenance costs. To find this minimum, the cost structures of the measures under consideration and their effect in terms of energy savings must be known. Of course, the result of any optimization calculation will depend on the underlying energy prices. To optimize the bundles, the single measures, their investment costs and their impact on the energy performance

---

<sup>20</sup> EuroPHit, project description, PHI, Darmstadt, 2013

are evaluated.

Considering ECMs for buildings, the first issue is to find a cost-efficient combination of thermal insulation measures for windows and the thermal envelope on external walls, basements, and roof tops to reduce the heat losses through the envelope.

The optimization process can be carried out using modeling, which requires a rather arduous iteration process. In this Darmstadt case study, the first approach was carried out with an estimative U-value-based method using a one-step iteration of modeling results from different scenarios.

### Estimative method

The estimative method refers to a simplified method using the degree days approach, considering that the heating degree days are a function of the average  $U_m$ -value of the building's envelopes. With a lower  $U_m$ -value, the number of heating degree days is reduced, linearly in a first approximation, which leads to a (slightly) non-linear function of  $qh(U_m)$ . Here, in addition to the transfer losses  $q_T$ , ventilation losses are also included, using a ventilation rate of  $nV = 0.6 \text{ h}^{-1}$ .

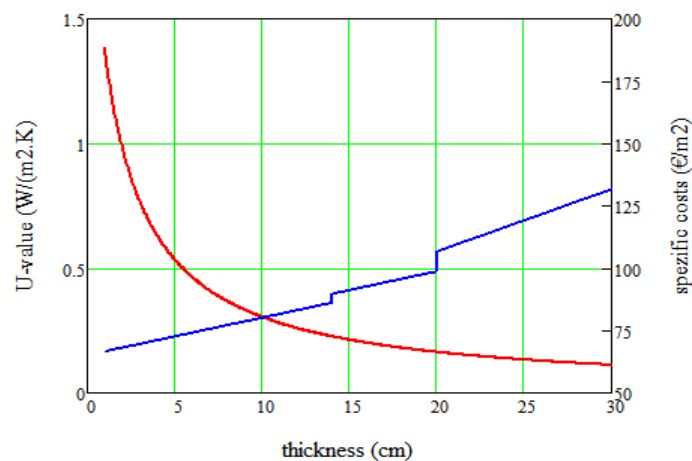

Figure B-3. U-value of external wall (red curve and left vertical scale) and insulation costs (right vertical scale) as function of thickness (heat transfer coefficient =  $0.035 \text{ W/m}^2\text{K}$ ).

The calculation of this estimative method is depicted for the wall insulation. Here the heat transfer loss is directly proportional to the U-value. Figure B-3 shows that the incremental benefit of additional insulation (decreasing U-value) decreases with thickness, while the costs increase more or less linearly. The discrepancy between the decreasing impact (saved energy per floor space) and the steadily increasing investment costs creates a cost/benefit equation with a cost minimum at a performance maximum for a certain thickness of the insulation. The specific heat transfer losses of the external wall, for example, as a function of its U-value ( $U_w$ ) are proportional to  $U_w$  times the temperature difference  $\Delta T$  between indoor and outdoor temperature. Over the heating period, with varying outdoor temperatures and fixed indoor temperature  $T_i = 20 \text{ }^\circ\text{C}$ , the annual heat loss  $q_T$ , using the degree days approach, is given by:

$$q_T = \frac{24}{1000} \cdot U_W \cdot H_{15} \quad \text{kWh/m}^2\text{yr (kBtu/ft}^2\text{yr)}, \quad (\text{B-1})$$

with the number of degree days,  $H_{15}$  (Kd), depending on the climate in the given location, for a building with heating limit temperature  $T_h = 15$  °C (59 °F). In this specific case study,  $H_{15} = 2,050$  Kd is chosen. The benefit of additional insulation of thickness  $d$  with U-value  $U(d)$  is the amount  $q_T(d)$  by which the heat losses (per  $m^2$ ) are reduced.

$$\Delta q_T = \frac{24}{1000} \cdot (U_W - U(d)) \cdot H_{15} \quad \text{kWh/m}^2\text{yr (kBtu/ft}^2\text{yr)}. \quad (\text{B-2})$$

Remark: In this modeling case study the embedded energy is not considered. If taken into account for large insulation thicknesses, the energy content of the insulation material, the embedded energy ( $\text{kWh/m}^2$ ) must be subtracted from the energy savings  $\Delta q_T$  of Equation A2.2.

Employing the cost structures described above, a “least-cost” curve of these measures can be derived. This least-cost path is achieved by a stepwise comparison of the capital, energy, and, in this case, maintenance costs of every possible saving measure.

As each of the data points for capital/energy and total costs represents one specific measure bundle, the quantitative result of this model is a list of measures that contribute to the combination of measures that are implemented to achieve the minimized total heating costs (capital costs plus energy costs) of the considered building or building type.

### Iterative NPV optimization

The iterative NPV considers the results of the energetic and economic modeling results for each scenario. By assessing the resulting energy consumption and the investment costs, the most cost-effective measures were identified. In the iterative method, a comparison is made of NPVs of the part of LCCs that are considered: energy, maintenance, and capital costs. In this modeling effort, the results were optimized by NPV. The results are shown and discussed in Figures B-4 and B-5.

To fine tune the results, consideration was given to which measures contribute in which way to the energy efficiency and at what cost.

In a first approach, the impact of each measure is assessed by comparing specific energy savings to the U-values of measures in different scenarios for this case study. Figure B-4 shows the relation between U-values and their resulting energy savings. Increasing the U-value of the wall by 0.1 provides energy savings of  $9 \text{ kWh/m}^2\text{yr}$  ( $2.85 \text{ kBtu/ft}^2\text{yr}$ ). A comparable result can be achieved by increasing the rooftop insulation by 0.1. In the case of the window, the equivalent value is  $7 \text{ kWh/m}^2\text{yr}$  ( $2.2 \text{ kBtu/ft}^2\text{yr}$ ). For the basement ceiling insulation, the equivalent result occurs with a value of  $5 \text{ kWh/m}^2\text{yr}$  ( $1.6 \text{ kBtu/ft}^2\text{yr}$ ).

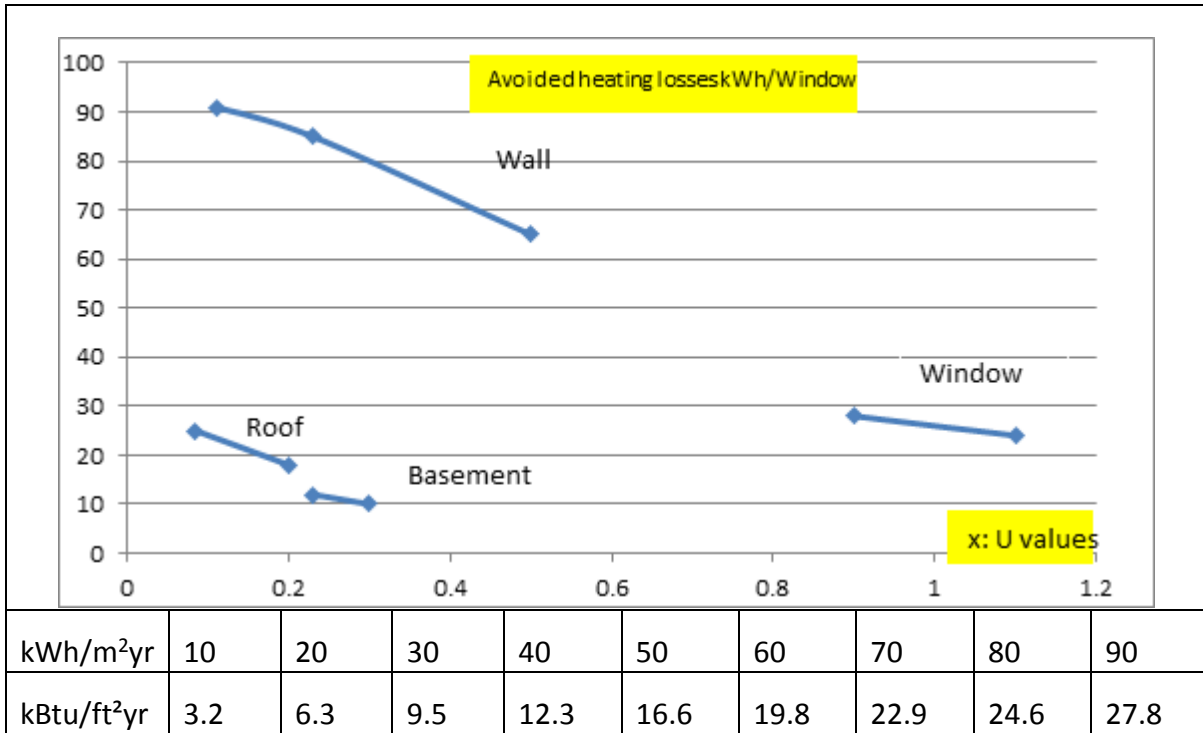

Figure B-4. Energy savings per U-value improvement in the Darmstadt case study.

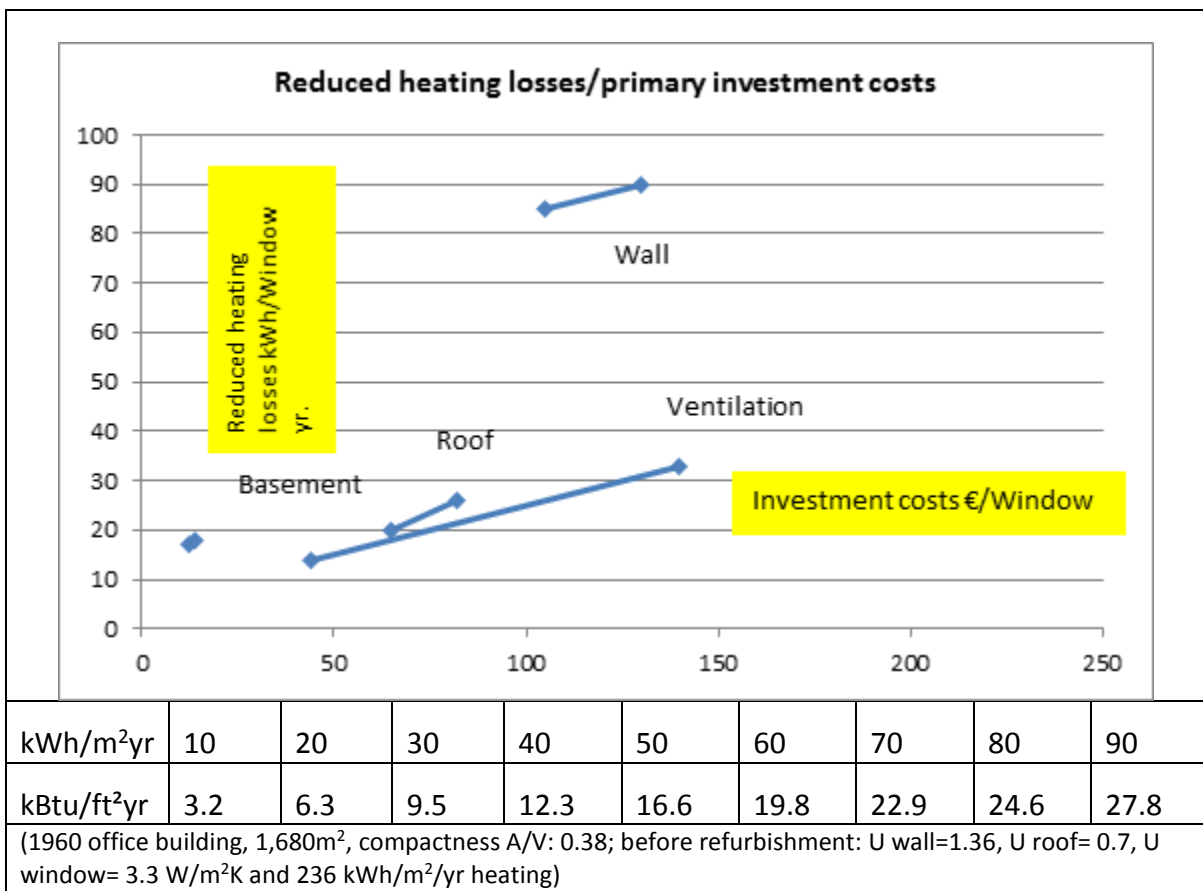

Figure B-5. Investment costs and heating loss reduction.

In a second step, the investment costs of thermal insulation measures and their impact on the energy balance of the specific building are assessed in Figure B-5. This shows the investment costs per m<sup>2</sup> heated floor space of different modeled measures, the energy savings per heated floor space, and delivers the ratio of annual energy savings per m<sup>2</sup> and € investment costs.

The highly cost-efficient external wall insulation is responsible for the largest amount of savings. However the impact per additional primary investment between the right (Passive House) side of the wall insulation curve and the left side (building code for new buildings) is comparably small: an additional 30 €/m<sup>2</sup> (2.9 €/ft<sup>2</sup>) in investment costs only contributes to 8 kWh/m<sup>2</sup>yr (2.9 kBtu/ft<sup>2</sup>yr) of energy savings. A comparable result is achieved with the roof insulation (flat roof).

### **B.5. The investment in a high-efficiency ventilation system with heat recovery shows a minor additional investment compared to an exhaust air ventilation system. Primary or source energy calculation**

For the site energy balance, the fuel-specific source energy  $pe$  is calculated with reference to national databases for potential energy (PE) factors, GEMIS,<sup>21</sup> which considers a global emissions model for integrated systems (Table B-6). The PE of electricity refers to the German electricity mix. To single out the impact of the ECM bundle, the calculation has to be done for the first time after assigning the building concept with a reference energy supply. In this case study, the chosen supply system was district heating.

Table B-6. Fuel-specific primary energy and CO<sub>2</sub>-equivalent factors (including all greenhouse gas emissions) used in Germany (Jank, 2015).

	<b>Primary Energy Factors kWhPE /kWhEE</b>
Lignite	1.21
Hard coal	1.08
Natural gas	1.12
Heating oil	1.11
Wood chips	0.06
Wood pellets	0.14
Thermal solar	0.15
Photovoltaics (PV)	0.61
Wind	0.06
Electricity mix 2014	2.13

<sup>21</sup> GEMIS database, global emission model for integrated systems, gemis.de; 2014

Table B-7. Site and source energy EUIs.

Energy	Baseline (Scenario 0)		Minimum Standard (Scenario 1)		DER (50%) (Scenario 6)		Passive House (Scenario 3/4)	
	ΔE (%)		ΔE (%)		ΔE (%)		ΔE (%)	
	Site	Source	Site	Source	Site	Source	Site	Source
Calculated energy savings [%]	0	0	40%	39%	55%	53%	81%	76%
Calculated energy savings [kWh/ m <sup>2</sup> yr] (kBtu/ft <sup>2</sup> yr)	0	0	103 (33)	119 (38)	142 (45)	163 (52)	208 (66)	235 (75)
EUI [kWh/m <sup>2</sup> yr] (kBtu/ft <sup>2</sup> yr) energy consumption calculated	256 (80)	307 (97)	153 (49)	188 (60)	114 (36)	145 (46)	48 (15)	72 (23)

## B.6. Results of the decision-making process

With regard to the implementation of the case study results in a practical decision-making process, two NPVs have to be considered:

- The first one considers the energy-related investment and capital costs and the energy and maintenance cost savings using NPV. This is to determine the energetic level and assumes that the maintenance-related investment costs are given and have to be financed anyway to keep the building functional. This perspective is relevant, i.e., if a government provides funding for repurposing (seed money) and the energy-related measures have to be funded in an EPC.
- The second NPV includes the global investment and capital costs in the calculation, and that the energy and maintenance cost savings must exceed this calculated cost.

Capital costs assume a funding of 100% of the investment costs by loans, with an interest rate of 2.5% and a pay off period of 20 years.

### Comparison of NPVs of energy-related investments, costs and benefits

This scenario could support the decision-making process if the basic costs are funded by a different source that is not related to the energy, and if non-energy-related cost savings are not to be taken into account.

- All NPVs are positive: For all scenarios the NPVs of savings are larger than the NPVs of costs, which means they are cost-effective within a 33-year time period.
- The best NPV is generated by the EnEV building code for new buildings, followed by the cost-optimized Passive House scenario.

Four main parameters of the economic modeling influence the positive NPV results:

- The long time period of the economic model over which the costs and savings are collected.
- The above-average price for heating energy: actually 0.1 €/kWh.
- The fixed interest/discount rate over the complete financing period of 20 years.

A sensitivity analysis with a lower price for heating energy (0.06 €/kWh) assumed that annual costs for the maintenance equal 0.025% of new investment costs; this was

taken into account in the NPV of all scenarios. In this case, the price scenario is still positive, but is reduced to 25% of the NPV generated without these adjustments. Thirty-three years is a long time period that will not be attractive for short- and medium-term capital.

The graph in Figure B-6 shows the net NPV for the refurbishment of Scenarios 1, 2, 3, and 6. It is the sum of the savings of energy and maintenance costs, deducting the energy-related cost for the refurbishment in 33 years. All values are discounted to the present value. The different colors of the columns show the NPV for different energy price increase scenarios. (Blue = 0% energy price increase, red = 2%, green = 4%).

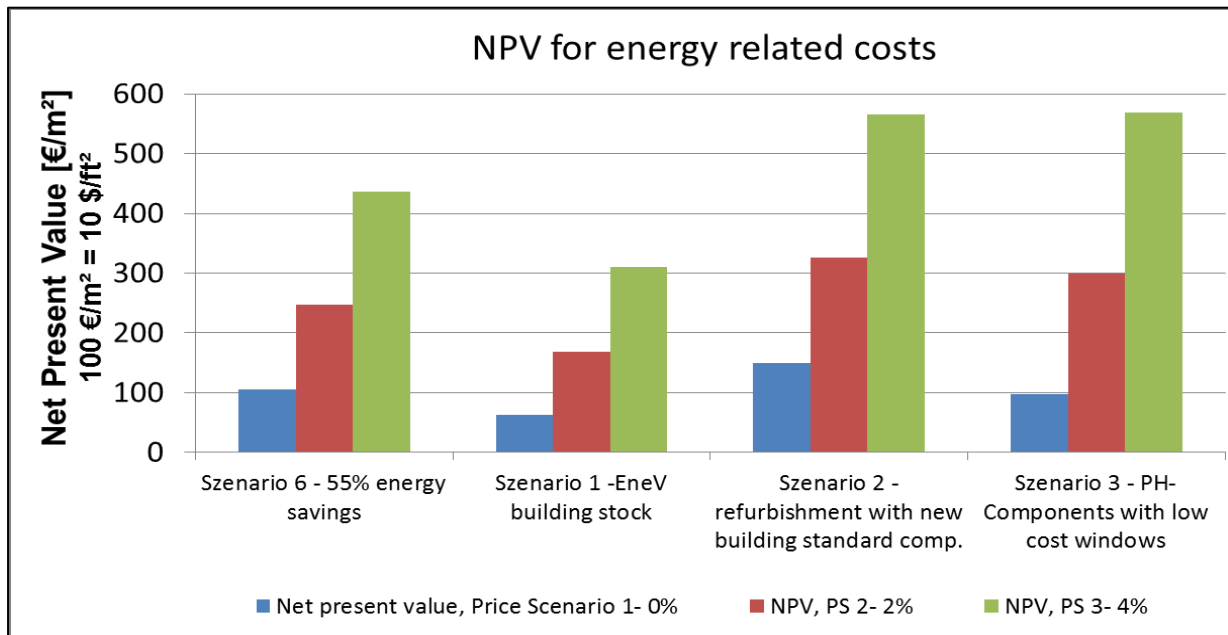

Figure B-6. NPV of different scenarios of energy-related investment costs per m<sup>2</sup>.

The graph in Figure B-7 shows the NPV for the refurbishment of Scenarios 1, 2, 3, and 6. It is the sum of the energy and maintenance cost savings minus the global cost for refurbishment over 33 years. All values are discounted to the present value. The different colors of the columns show the NPV for different energy price increase scenarios (Blue = 0% energy price increase, red = 2%, green = 4%).



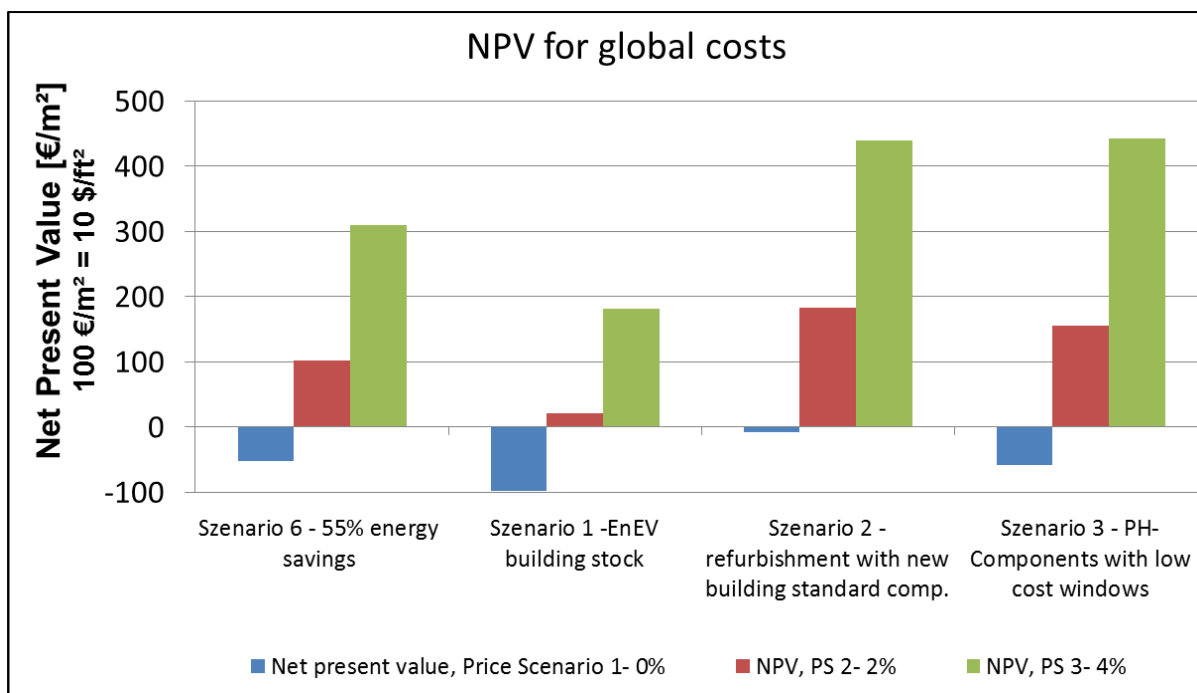

Figure B-7. NPV of different scenarios of global costs per m<sup>2</sup>.

### Comparison of global cost NPV

In this scenario, the total investment costs, energy-related costs, and basic costs together are accounted for in the decision-making. This is the case for most of the business and funding models, as it assumes that all costs are funded and will have to be paid back completely to an investor, bank, funds or ESCO.

- Except for price in Scenario 1 (without an energy price increase), all NPVs are positive for all scenarios. The NPVs of savings are larger than the NPVs of costs.
- The best NPV is generated by the EnEV building code for new buildings (Scenario 2). Next is the cost-optimized Passive House (PH) scenario (Scenario 3).

If the calculation is carried out with a lower price for heating energy (0.06 €/kWh) and the assumption that annual maintenance costs equal 0.025% of new investment costs, the NPV of all scenarios is negative with no price increase. When calculating a 2% price increase most scenarios (except for Scenario 1) turn positive. The payback period of the best scenarios is in the range of 33 – 37 years.

## B.7. Summary and conclusions, metered performance

### Results of the decision-making process

This research work was done under IEA EBC Annex 61 “Business and Technical Models for DER,” which targets the identification of high-efficiency measure bundles for deep retrofit projects. KEA collected some 20 well documented building refurbishment projects and picked an office building from the 1960s, which was refurbished in 2012/13 according to a PH standard.

For this building a modeling case study was set up to calculate at least three different scenarios (minimum requirements by German building code, – 55% energy savings and

a PH scenario). An additional scenario was created by optimizing the cost effectiveness of the DER measure bundle based on the NPV. The NPV was calculated from the capital, energy, and maintenance costs of each scenario. The economic model uses an average life time period of the measure bundles of 33 years. It is assumed that, due to national practices, the loan payback period will be not more than 20 years to completely payback the investment and interest.

The technical and economic assessment of the scenarios shows the following results:

- The standard scenario fulfills the requirements given by national building code EnEV 2014 for refurbishment of the building stock by refurbishing only a part of the building construction. In this case study, to show a technical sub-optimal solution, a refurbishment of windows and the roof would be sufficient. With energy savings of 40% this scenario is not economically competitive with more ambitious measure bundles.
- For the “– 55%,” which is Scenario 6, the results are more competitive. To comply with – 50%, a partial refurbishment that includes the efficient window and a shallow layer of insulation either on the roof or the wall will be sufficient. In the case study, the thin wall insulation from Scenario 6 would save 55% of heating, but would not comply with the national building code and should not be considered.
- The EnEV 2014 building code for new buildings and the cost-optimized PH standard both lead to deep refurbishments (> 70% of energy savings according to the Building Performance Institute Europe definition) and result in competitive economic results. These two scenarios would pay back the total investment, not simply the energy-related part of the investment.
- This economic equation does not show the benefits of the higher comfort of the air ventilation system with heat recovery, with incoming fresh air at close to room temperature and a reliable air exchange.

#### **Actual performance of the building in 2013/2014**

Since the 2012-2013 building renovation to achieve the PH level of energy use, 2 years of energy data have been collected. The collected data show that the actual heating energy use of the building in 2013/2014 was about 5% higher than what was estimated through calculations. This results in 78% heating energy savings (51 kWh/m<sup>2</sup>yr for heating and DHW) with a payback time of 28 years. The major reason for the higher energy use is losses in the heating distribution network. Consideration is being given to at least partly refurbish parts of this grid.

The expanded modeling analysis shows that, to improve cost effectiveness of the DER project, performance specification requirements for the design relating to details of implementation of window replacements and mitigation of thermal bridges had to be considered very carefully in the RFPs. A driver for cost effectiveness is the least-cost planning calculation to streamline and fine tune the design of the bundles of DER measures.

#### **B.8. Assessment of Subtask C KPIs**

1. The cost effectiveness of renovating very old and dilapidated buildings and implementing advanced ECMs, instead of demolishing the buildings and

- constructing new ones: The Darmstadt case showed a cost-effective DER refurbishment targeting PH standard with a dynamic payback period of 28 years.
2. Reducing building energy use to make it feasible to achieve NZE with renewable energies such as biomass and photovoltaics. The refurbishment in Darmstadt only considered demand side measures such as thermal envelope and high performance glazing. It did not account for RE.
  3. Bundle advanced and complementary ECMs to achieve DERs with savings of 50% or more. With the bundle of technologies depicted in Scenario 4 (Table B-7), a total heating consumption reduction of 78% was achieved in this project.
  4. Evaluate the areas where more prescriptive design and construction criteria are recommended in future DER projects. To improve cost effectiveness, the design and installation of replacement windows and the avoidance of thermal bridges had to be considered very carefully in the RFPs. A driver for cost effectiveness is the least-cost planning calculation to streamline and fine tune the design of the bundles of DER measures.
  5. Verify the use of existing QA process guidance throughout all project phases (from commissioning and subject matter expert input during the development of the RFPs to post-occupancy performance data evaluation and remediation during the warranty period) and need for further training. In the case of the Darmstadt project, the QA process was implemented in the early phases of planning. The specific construction issues of this building were related to the mitigation of thermal bridges at windows, shades, outside doors, and the roof/wall intersection. Also, the uncontrolled ventilation in the sanitary areas was designed in detail and became a part of the tendering documents. The companies awarded the application of the thermal envelope measures, the implementation of windows, and the ventilation system installation had to prove their experience in similar projects and were required to provide trained staff on the construction site. After the work is accomplished, a blower door test and thermographic photography were done. It is obvious that through the early integration of manufacturers the process could have been streamlined and planning and labor costs could have been reduced even more.
  6. Assessment of new financing mechanisms of DER with combination of private and public funding: this building received grants of 25% of the incremental investment costs (delta between minimum requirements and the component and labor costs for PH design) and a low interest rate. No ESCO was involved. The responsibility for the operation and performance of the building has been handed over to the building owner with the completion of the refurbishment work. Obviously, the operation, monitoring, and verification of the implemented measures is not a priority for the building owner. Since there is no retrocommissioning, there is still further potential for optimization. Even though it was necessary to declare certain energy targets to collect the grants and subsidized loans, the planners of the measures are not responsible for the energy performance of the building; this responsibility rests with the building owner.

## B.9. References

Footnote #	Title, author, year, language (DE: German)
1	PHPP Passive House Planning Tool, PHI, Darmstadt 2010–15
2	Assessment of eight accomplished DER projects in eight German public buildings, EDLIG, 2014 (DE)
3	Prebound und Rebound Effekt in der energetischen Modelierung, IWU Darmstadt, 2013 (DE)
4	EnEV German energy efficiency ordonnance, 2014, Berlin (DE)
5	VDI 2067, German industrial standard 2067, Paper 1, Beuth Verlag, Berlin 1993–2014
6	EuroPHit project description, PHI, Darmstadt, 2013
7	GEMIS database (Global emission model for integrated systems), gemis.de, 2014 (DE)
8	Integriertes Quartiers–Energiekonzept Rintheim–Methoden, Erfahrungen, Ergebnisse, Fraunhofer Verlag Stuttgart, 2015
<b>BBSR</b>	BBSR, 2014 BUNDESINSTITUT FÜR BAU-, STADT-UND RAUMFORSCHUNG (BBSR) IM BUNDESAMT FÜR BAUWESEN UND RAUMORDNUNG (BBR) (HRSG.): Kosten energierelevanter Bau- und technischer Anlagenteile bei der energetischen Sanierung von Nichtwohngebäuden/Bundesliegenschaften (2014), BBSR-Online-Publikation 06/2014, Bonn (DE)
	Jungmeier, G., et al.: GEMIS-Österreich, Energetische Kennzahlen im Prozesskettenbereich Nutzenergie-Energiedienstleistung. JOANNEUM RESEARCH Forschungsgesellschaft Graz, Mai 1997. In KREP 2000, Handdbuch für kommunale und regionale Energieplanung. Erschienen 2001, JOANNEUM Research, Graz
	OIB- Richtlinie 6, Energieeinsparung und Wärmeschutz, October 2011.Österreichisches Institut für Bautechnik (DE)
	DIN 18599; Edition 2012, Deutsches Institut für Normung, Berlin, Beuth- Verlag (DE)

## Appendix C: Barracks, Almegårds Kaserne, Bornholm, Denmark

### C.1. Name of the project, location

Almegårds Kaserne, military accommodation in Bornholm-Denmark.

Pictures of Almegårds Kaserne before and after renovation



On the left (a & c) before the energy retrofit. On the right (b & d) after retrofit.  
 Source: Grønne Etablissements. Fase II. Almegård Kaserne /19113.Forsvarets Bygnings og Etablissementstjeneste (FBE). March 10, 2014.

Figure C-1. Bldg. 3 of Almegårds Kaserne.

### C.2. Project summary

Key features of the retrofit

- New hot water pump for charging and circulation.
- New heat distribution pumps for space heating.
- New lighting system.
- Insulation of distribution piping for heating.
- Water savings measures.
- Improved air tightness of building.
- New exterior doors.
- Roof insulation.
- New external wall with new insulation.
- New ground floor insulation.
- Three-pane low energy windows.
- DHW storage tank.
- Mechanical ventilation with heat recovery (MVHR).

- Building energy management system (BEMS).

### **Project objectives**

The objective is to create a demonstration project for the Danish Defense for the environmentally sound and sustainable development of Defense establishments, including structures, buildings, installations, processes, and behavior. The overall goal of this specific project is to reduce energy consumption and CO<sub>2</sub> emissions and promote sustainable solutions.

The measures introduced include environmental and energy management, increased use of RE, reduced water consumption, and the promotion of environmentally friendly equipment. At the same time, the renovated and new buildings must provide value in social, functional, aesthetic, and sustainable terms.

### **C.3. Project energy goals**

The Danish Defense has the goal that at least 50% of all new buildings should reach Building Class 2020 as defined in the Danish Building Regulations, and 50% of new buildings must be sustainability certified.

The project Green Establishments stems from the Climate and Energy Strategy 2012-2015 of the Ministry of Defense, which was launched in April 2012.

These Climate and Energy Strategy objectives include a cost-effective reduction of CO<sub>2</sub> emissions from Danish Defense activities and facilities within Denmark and during operations abroad. At the same time the strategy helps to minimize energy consumption and maintain it at the lowest level. The reduction in energy consumption is achieved through combined efforts in improving building physics, implementing technical solutions, and influencing user behavior.

The overall objectives for Almegårds Kaserne are:

- Reduction of resource consumption:
  - 40% reduction of CO<sub>2</sub> emissions.
  - 50% reduction in heat consumption.
  - 30% reduction in electricity consumption.
  - 30% reduction in water consumption.
- Conversion to RE:
  - 50% heating contribution by RE systems.
  - 60% electricity contribution by RE systems.

### **C.4. Summary project description**

The Almegårds Kaserne project is conducted by the Danish Defense Construction and Infrastructure (FBE) on behalf of the Ministry of Danish Defense Administration. In practice, FBE provides buildings and land for the Danish Defense and is responsible for O&M of the physical plants as well as new construction and spatial planning.

The project is carried out in an area with associated structures functioning as accommodation, classrooms, offices, garages and workshop facilities, training areas, etc.

The Almegårds facility is a very homogeneous, restrained architectural design; it is a unique complex of wooden barracks from the mid-20th century. They are part of the cultural heritage and thus their design needs to be respected during the development project. Change of these preservation-worthy buildings requires deep analysis and well-argued and well-founded solutions not only regarding sustainability of performance, but also at the functional, social, and architectural level.

In addition to respecting the cultural architectural heritage, the proposed renovation incorporates several sustainability elements that reduce energy consumption and water use to create a showcase for green industry. The project focuses on the following areas:

- Energy efficiency of buildings.
- RE and energy conversion.
- Climate change mitigation.
- Use of rainwater.
- Green areas.
- Energy efficient behavior.
- Social outdoor spaces.
- Renovation structure.

A demonstration area was chosen as a representative sample of Almegårds Kaserne and embraces both the spirit and atmosphere of the entire facility. In practice, the demonstration buildings have been selected for three different levels of energy renovation: Small (S), Medium (M) and Large (L). Small Action corresponds to the implementation of energy-saving measures to achieve the energy requirements for existing buildings according to the Building Regulations 2010 (BR10). Medium Action results in profitable improvements, and Large Action results in achieving the same level of energy use as for a new building. Almegårds Kaserne consists of 93 buildings in total; six buildings were chosen as the most representative of two categories. The buildings appear identical and are numbered at the site. No. 3, 7, and 10 are used for accommodation and 4, 6, and 11 are administration buildings. The buildings are similar in architectural terms and building technical condition, and they are easily comparable and measurable against each other. Bldgs. 10 and 11 renovated to Small Action, Bldgs. 6 and 7 to Medium Action, and Bldgs. 3 and 4 to Large Action. The buildings' uniformity and physical context make it possible to create a concentrated and visually coherent area in which both buildings and outdoor areas are involved in the demonstration projects. The demonstration area and the numbered buildings can be seen in Figure C-2 below.

Building number 3 has been chosen to be representative of the two buildings renovated to level Large. Therefore, Bldg. 3 is analyzed and described in this paper as a DER case study.

The energy measures to be carried out for Bldg. 3 are the following:

1. Energy renovation: The conversion of the area from worn wooden barracks to functional, flexible and, in an energy sense, contemporary buildings with low energy use corresponding to new buildings according to BR10. The facades are

processed to some degree, with reinterpreted wood cladding, replacement of all windows and new facade openings, all with shutters that filter the light. The renovation involves a significant shift in the inside climate conditions, in daylight, in the experience and in the users' living qualities.

2. Solar thermal collectors.
3. Windmill.

### **C.5. Stage of construction**

The project described in this report is the final proposal of the project. However, it is still under construction and expected to be finished by 2017.

### **C.6. Point of contact information**

Project Manager: Kim Bent Rasmussen.  
 Forsvarsministeriets Ejendomsstyrelse.  
 Projektsektion 2, Kastellet Nordre Magasin 58, 3 etage.  
 2100 København Ø.  
 Tlf: +45 72314552 email: [fes-proj202@mil.dk](mailto:fes-proj202@mil.dk) [www.forsvaret.dk/fes](http://www.forsvaret.dk/fes).

### **C.7. Date of the report**

September 8, 2016.

### **C.8. Site**

Location: Rønne, Bornholm, Denmark.  
 Latitude: 55.12°.  
 Longitude: 14,71°.  
 Elevation: 16 m.  
 The climate zone corresponds to the zone 5A (ASHRAE).  
 Cooling degree day: 0.  
 Heating Degree Days (based on 17 °C) : 2850.  
 Heating Design Temperature: -12 °C (Dry Bulb Temperature).  
 Cooling Design Temperature: N/A.

### **C.9. Building description / typology**

#### **Type**

Military accommodation.

#### **General information**

The traditional red-painted wooden buildings were erected in 1947 when the Danish army units moved to the island Bornholm in the Baltic Sea. In the beginning of the 1960s, an expansion and modernization of Almegård Kaserne was carried out.

Year of previous major retrofit: No previous major retrofit.

Year of current renovation: 2015-2017.

Total floor area (m<sup>2</sup>): 1,471.



## C.10. Architectural and other relevant drawings



Source: Grønne Etablissementser. Fase II. Almegård Kaserne /19113. Forsvarets Bygnings- og Etablissementstjeneste. 10 Marts 2014

Figure C-2. Master plan of the military establishment Almegård Kaserne. In the upper part of the plan is the demonstration area, with Bldg. 3, the DER case.



Figure C-3. Close-up of the demonstration area. Case study Bldg. 3 is located at the left.

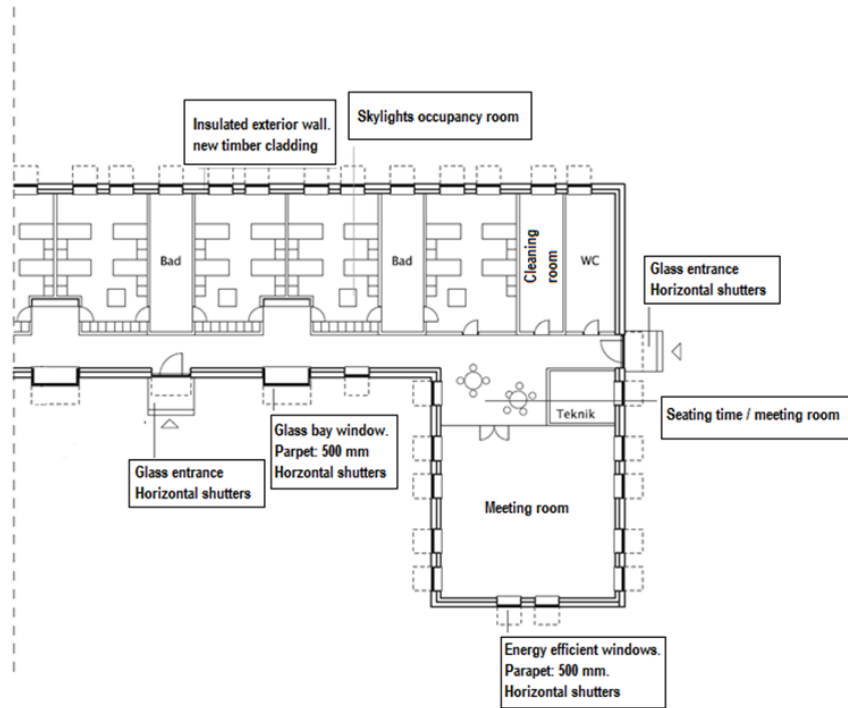

Figure C-4. Floor plan of Bldg. 3 with the energy retrofit measures.

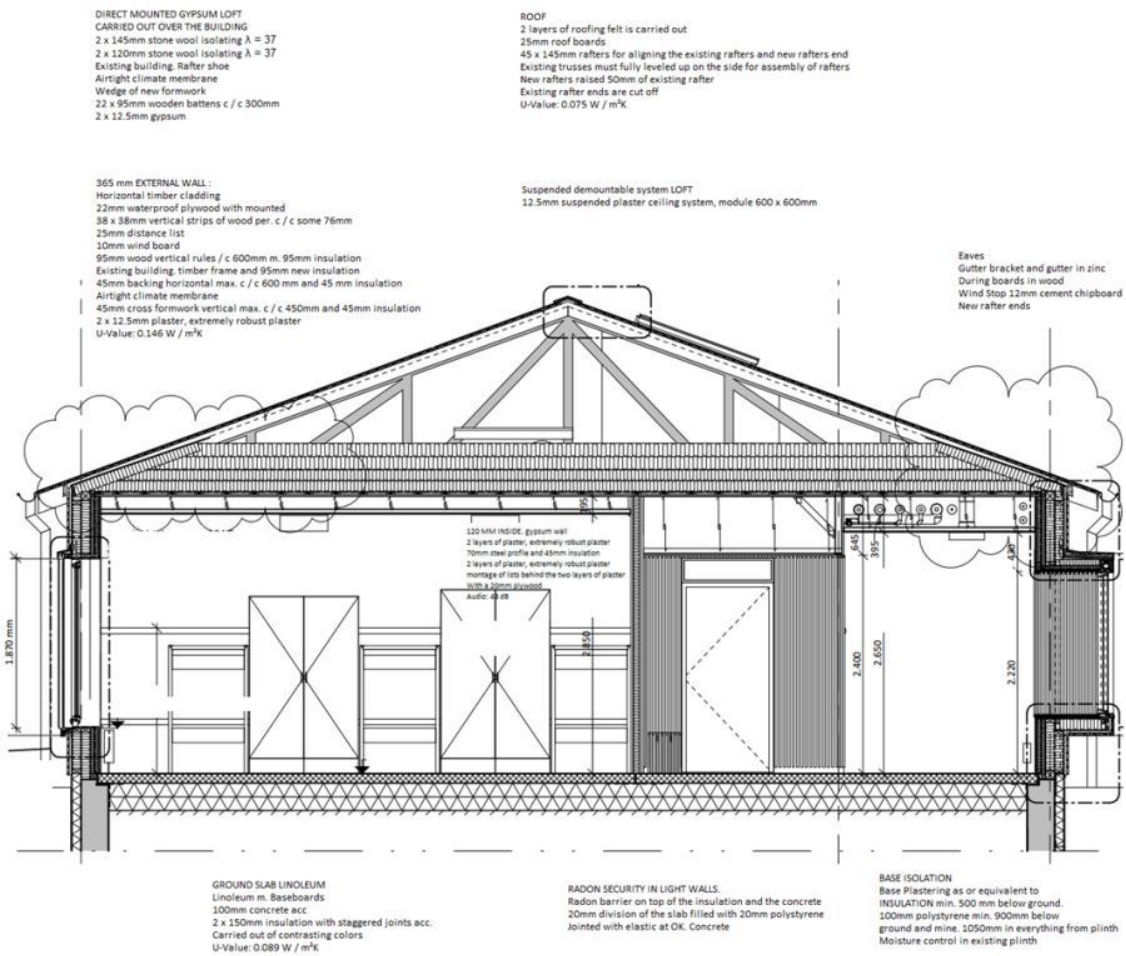

Figure C-5. Construction details on a section of the study case Bldg. 3.

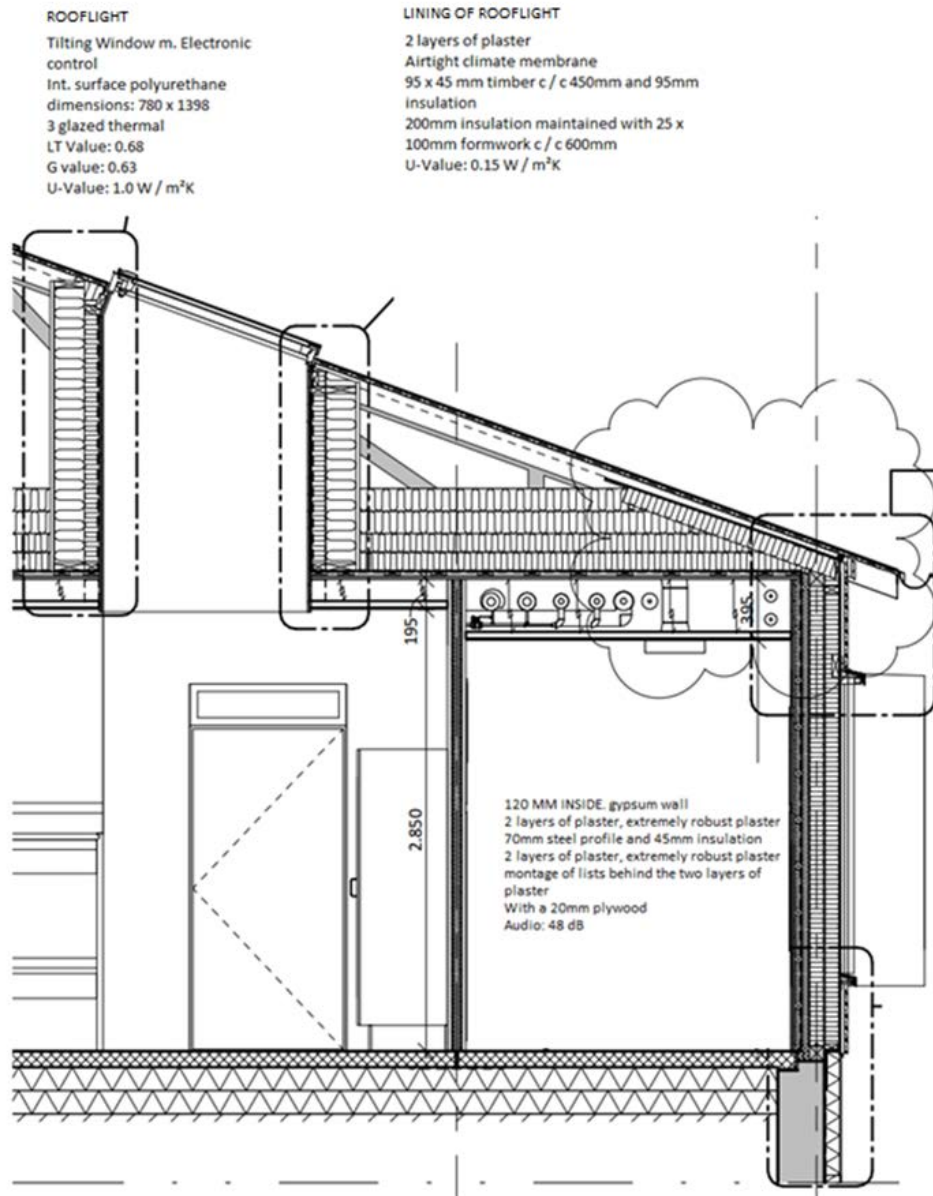

Figure C-6. Construction details on a section of the study case Bldg. 3.

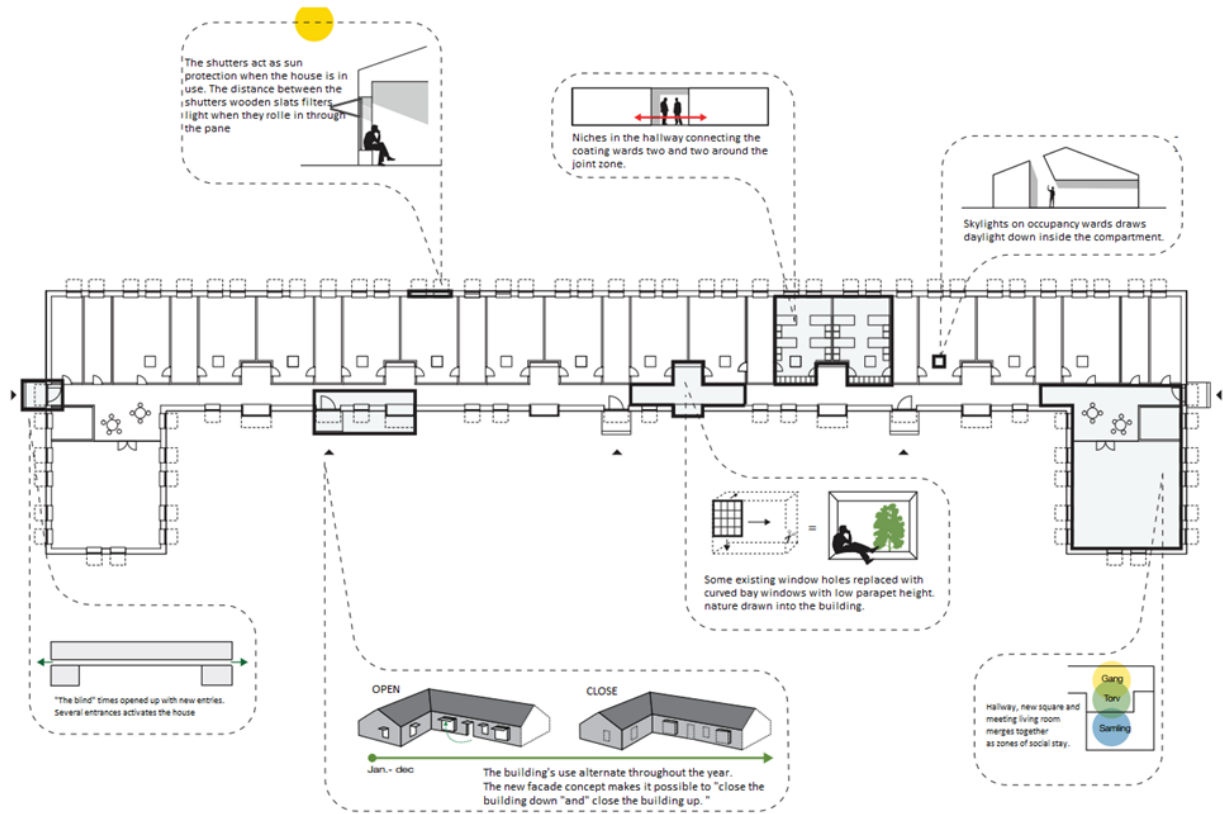

Figure C-7. New initiatives for case study Bldg. 3.



Figure C-8. Rendering of the new Bldg. 3 façade.

### C.11. National energy use benchmarks and goals for building type

**National energy target for this type of building:** The Danish Building Regulations (BR15) require that this type of building at a minimum be renovated to “renovation class” 2 =  $(110 + 3200/\text{Area})$  kWh/m<sup>2</sup>/year, and the energy consumption reduced by at least 30 kWh/m<sup>2</sup>/year, or follow a table of detailed recommendations for U-values.

### C.12. Site energy cost information

#### Electricity

263 Euros/MWh = 295 \$/MWh.

#### District heating

75.2 Euros/MWh = 84.4 \$/MWh.

### C.13. Pre-renovation building details

The buildings erected around 1947 are typically red wooden system construction. All buildings have a varying level of maintenance and many of the buildings fall in the least energy efficient end of the energy class labeling scale.

#### Envelope details: walls, roof, windows, insulation levels.

The building construction is characterized by little or no insulation, with moisture and rot in the construction, as well as lots of leaks in the building envelope and poorly insulated windows.

The buildings are maintenance-heavy due to their poor condition and problems with the indoor climate.

#### Heating, ventilation, cooling and lighting systems

The existing building was heated by central district heating. The Danish Defense until now has used RE only to a limited extent. However, there is a small production of RE at the newly-constructed photovoltaic plants at Almegårds Kaserne with an annual production of 9.1 kWh/m<sup>2</sup> (building area).

#### Description of the problem: reason for renovation

The existing buildings have high energy consumption and poor indoor comfort due to the poor insulation level of the barracks’ building envelopes. The facades and windows need renovation due to their deteriorated condition.

#### Renovation SOW (non-energy and energy-related reasons)

Starting in 2012, the Ministry of Defense prepared a CO<sub>2</sub> statement based on the Danish Energy Agency’s guidelines on reduced CO<sub>2</sub>-emissions. The CO<sub>2</sub> statement is a statement about reducing the CO<sub>2</sub> emissions caused by Danish Defense activities.

The implementation of energy management and energy savings is expected to lead to considerable reductions in greenhouse gas emissions and energy costs by systematic control of the Danish Defense’s energy consumption.

## C.14. Energy-saving/process improvement concepts and technologies used

### Building envelope improvement

#### Construction

The building consists primarily of lightweight constructions comprising lightweight walls and ceilings with concrete slabs and aerated concrete walls around the shower / toilet.

The renovated barracks preserve the exterior window frames, but get sashes in glazing and interior isolation and veneer surfaces similar to new barracks. The exterior wood siding is changed using the same principle as for new barracks.

During future renovations, when the slab is removed, the building's interior, and especially the design for wet rooms, will be reconsidered. All walls and interior surfaces will be renewed.

All facade elements are totally renovated; only the original boundary structure is preserved. The buildings are insulated with environmentally friendly insulation and a new wooden external layer is installed. The ground slab is replaced, and the foundation is insulated externally. The facade renovation can be performed on site or produced as prefabricated elements for subsequent coating. The latter would be preferable, since prefabrication usually means a better working environment for artisans, more efficient use and better sorting of building materials, and ultimately less capital investment. Black tar paper is used to reverse the buildings' original expression. The attic is insulated, after the insulation of the technical installations is completed to ensure the opportunity for flexible routing of installations.

In summary, the renovation is carried out with the U-values and  $\Psi$ -values listed in Table C-1.

Table C-1. U-values and  $\Psi$ -values.

U-values of building envelope components	Values
Outer walls	0.15 W/m <sup>2</sup> K
Exterior wall in toilet/ shower	0.18 W/m <sup>2</sup> K
Ceilings	0.08 W/m <sup>2</sup> K
Ground floor	0.09 W/m <sup>2</sup> K
Ground floor with floor heating	0.08 W/m <sup>2</sup> K
Linear thermal transmittance of windows	0.12 W/mK
Linear thermal transmittance of foundation	0.16 W/mK
Linear thermal transmittance of foundation in the areas with floor heating	0.19 W/mK

#### Windows

Existing windows and doors are replaced by new 3-pane low energy windows with an expected U-value of 0.9 W /m<sup>2</sup>K and new doors with a U-value of 1.2 W/m<sup>2</sup>K. The new windows and doors will significantly improve the air tightness of the building envelope.

Active and passive shading will be installed. It is assumed that there are interior curtains with a shading factor (g) of 0.8 in the south and west-facing windows and that

$g = 0.63$  in the rest of the windows.

## **New HVAC, lighting systems, and retrofits to existing systems**

### **Ventilation**

A mechanical ventilation system will be installed with heat recovery throughout the building with a recovery rate of 80% when taking into account the heat loss from the ducts in unheated attic.

In the bedrooms a ventilation rate of  $0.75 \text{ l/sm}^2$  for 8 hours per day and  $0.3 \text{ l/sm}^2$  for the remaining time is assumed. Hallway and dining room rates will be  $0.3 \text{ l/sm}^2$  over 24 hours.

The building envelope airtightness is set to  $1.0 \text{ l/sm}^2$  at pressure testing conditions of 50 Pa.

The mechanical ventilation in bedrooms is supplemented with natural ventilation on hot summer days.

The specific fan power (SFP) for ventilation is  $\text{SFP} = 1.5 \text{ kJ/m}^3$ .

### **New lighting system**

LED lights and intelligent lighting controls will be installed.

The installation of window sills in the corridors and bedrooms, as well as the skylights in the living rooms, will result in significantly better daylight conditions and thus reduced electricity consumption for lighting.

### **New generation/distribution system**

The building heat is supplied by district heating, and buildings are heated with radiators and floor heating in bathrooms and toilets.

### **Heat distribution**

There will be new short and well-insulated piping for district heating in the building. All the heat distribution pipes are located in the building.

An automatically controlled pump (145 W), which controls the flow to the radiators, will be installed.

### **Water consumption**

The project includes water conservation with water-saving fixtures, and hot water is only used for personal hygiene. Water consumption is expected to be reduced by 25% relative to standard consumption ( $250 \text{ l/m}^2/\text{year}$ ).

A new hot water tank of 1000 liters with a heat loss of  $0.74 \text{ W/K}$  will be installed. It includes 100 m distribution pipes to DHW taps and 100 meters for circulation. The pipes will be insulated and heat loss is assumed to be  $0.21 \text{ W/mK}$ .

The primary pump for charging will be 100 W and the circulation pump 50 W. The water circulation pump will be switched off when there is no hot water use. No additional hot water for hand washing. The system is expected to run approximately

60% of the time.

## **BEMS**

Intelligent lighting and heating controls will be installed.

## **Renewable energy**

Solar heating and a wind turbine will complement the existing PV area. Annual PV production will total 324 MWh. The electricity is distributed to the entire barrack area of 37,751 m<sup>2</sup>. The PV contribution into the existing energy consumption is expected to be 9.1 kWh/m<sup>2</sup>.

## **Solar collector**

A central solar heating system is to be closely connected to the area's heating plant. The facility will consist of 500 m<sup>2</sup> of modern efficient flat plate collectors, which connect directly to the barracks' district heating (Figure C-9). The plant will be placed on the ground in an area where the optimal solar orientation can be obtained and where it does not interfere with the operational areas and needs just a short internal piping connection for the district heating network. The system is expected to provide about 50% of the barracks' heating consumption and, together with the share of renewables present in the district heating system, ensures that a large proportion of the barracks' heating supply comes from RE sources. The production of 200 MWh will be distributed to the whole barracks area of 35,751 m<sup>2</sup>. Thus the total solar energy contribution is expected to be 5.6 kWh/m<sup>2</sup>.

## **Wind turbine**

It is proposed to set up a wind turbine in close proximity to the area's PV systems. It is designed as a 25 kW<sub>p</sub> turbine with a height of 15-20 m and an expected annual output of 13 MWh, distributed to Bldgs. 3 and 4 (Figure C-10). The windmill will complement the solar plant's production of electricity and increase self-sufficiency on days with wind. It is an additional energy source for the many Danish overcast days when the solar cells do not provide optimal production. In the context of the solar system and the solar cells, a wind turbine is an effective and obvious step towards a greater degree of self-sufficiency.

The electricity contribution from the wind turbine to Bldg. 3 is expected to be 2.6 kWh/m<sup>2</sup>.





Figure C-9. Solar collector of 500 m<sup>2</sup>.



Figure C-10. Wind Turbine (25 kW<sub>p</sub>).

### **Waste and rainwater resource strategy**

The kitchen staff will have to organize their work in a new and more sustainable direction, where the goal is not just to serve a good meal, but also to reduce waste in the kitchen.

The amount of waste water will be reduced through the implementation of the following water-saving measures: water-saving lavatories, water-saving faucets, water-saving showers, pushbutton control of showers, water-saving appliances.

Rainwater is already used for washing cars and equipment and is managed via an oil

separator for a settling ditch with overflow of stormwater that relieves the load of waste water disposal. The proposed project included the use of collected roof and surface water for use in toilets, laundry, and car washes. The system is planned with the ability to further reduce water consumption by connecting bathing water from showers to rainwater tanks for toilet flushing. This will enable use of domestic water twice: first for bathing and then to flush toilets.

### **Daylighting strategies**

All window sills of the building have been lowered to seat height. The new windows are provided at the top with slanted shutters that, when closed, comprise an integral part of the facade. When the shutters are open, they are in a perfect location to provide optimum sun protection and ensure filtering of sunlight. To ensure optimal daylight conditions in all rooms, the density of shutter bars is regulated depending on the orientation of the windows. The windows facing west, east, and south will be supplied with a dense lamellar structure that provides strong shading. On the north, a more open structure is preferable.

All openings are fitted with shutters. This allows for a total shutdown of the facade during the relatively long periods when the buildings are empty or in limited use. This shutdown will lead to a reduction of the heat losses during the closed periods.

Today, the window area is just 10 – 11% of the floor area, which is quite a small share. Increased window area with new and larger windows and skylights will improve daylight with the possibility of also reducing electricity consumption for lighting.

## **C.15. Energy consumption**

The reduction in energy consumption is calculated and compared to the existing building consumption, taking into consideration the electric contribution for the photovoltaic panels installed before the energy retrofit. The measures have been classified into two separate demonstrations:

Demonstration 1 – Impact of LARGE renovation by the non-RE measure.

Demonstration 2 – Impact of the non-renewable and RE measure: RE of district heating, solar collector and wind mill.

### **Annual energy use reduction**

The data in Tables C-2, C-3, and C-4 show that the expected savings in heat consumption (equivalent to CO<sub>2</sub> footprint) by the LARGE Renovation non-renewable measure is 69%. An extra 47.5% energy savings will be achieved through renewable energy, resulting in total heating demand from the grid of 23.6 kWh/m<sup>2</sup>. In conclusion, the project's target will be met by saving more than 50% of heating energy. In addition, almost 50% of the remaining energy consumption will be produced by the RE systems, and therefore more than the targeted 40% reduction of the CO<sub>2</sub> emissions will be achieved.

Table C-2. Calculated annual energy use reduction for Demonstration 1.

Energy consumption [kWh/m <sup>2</sup> ]	Energy before renovation	Energy after renovation with LARGE action	Energy savings
Net heating consumption	146.7	44.9	101.8 (69%)
Total electricity	32.9	17.9	15 (45.6%)

Table C-3. Calculated annual energy use reduction for Demonstration 2.

Energy Demand [kWh/m <sup>2</sup> ]	Energy After Renovation	Thermal Solar Energy Contribution	District Heating Produced by RE	PV Contribution	Wind Turbine Contribution	Energy Savings from RE	Energy after Renovation and Renewable Systems	Total Energy savings
Net Heating consumption	44.9	5.6	15.7			47.5%	23,6	123.1 (84%)
Total electricity	17.9			9.1	2.6	65%	6.2	26.7 (82%)

Table C-4. Almegårds Project energy target.

Energy target	Energy demand reduction	Energy demand from renewable sources	CO <sub>2</sub> footprint reduction
Heating	50%	50%	40%
Electricity	30%	60%	40%
Water	30%		

Moreover, electricity savings in demonstration projects include:

- New circulation pumps in the heating systems.
- New lighting systems with intelligent lighting and LED light sources.

A 45.6% reduction in electrical consumption will be achieved by the principles of passive energy design, whereby the daylighting is optimally exploited in the buildings. This means that the objective of a 30% reduction in electricity consumption will be met to a large extent.

The project also introduces a number of initiatives to induce appropriate user behavior, such as apps with visible measurement of heat consumption and educational performance views that provide the basis for comparisons with neighbors and the development of one's own unit consumption.

The fresh water consumption will be reduced by 48% by the measures described in the previous section.

## C.16. Energy cost reduction

See results in Section C.20.

### C.17. Non-energy-related benefits realized by the project

- The renovation as described provides the opportunity to manage not only energy, but also the daylight and passive solar heating. The renovation will result in a significant shift in the indoor climate conditions, in daylight, in the experience and in the users' living qualities.
- Initiatives are implemented focusing on optimizing functions and areas of the region, initiatives to create energy and resource savings, better working environments, job satisfaction, and a more rational everyday life, where environmental awareness is included as a matter of course. Sustainable initiatives within both environmental-, economic- and social-sustainability are incorporated into a holistic plan that is energy efficient and low waste, provides increased quality of life and high visibility, and demonstrates how barracks can serve as a model for a green and sustainable workplace.
- Both "dead ends" of the corridor are supplied with new entrances with glass doors. The increased number of entrances and window openings facing the courtyard will change the use of the house and animate the building in a new way. The new openings to the outdoor space reduce the boundaries between inside and out and enhance the contact between the passageway and courtyard.
- Architectural quality: This effort has resulted in a much more refined and sensitive approach to handling the landmark facades. Cladding is maintained as a facade material, and enhancement of daylight is accomplished while respecting the facades' original expression and rhythm. See results in Section C.20.

### C.18. Renovation Costs

See results in Section C.20, Table C-5.

### C.19. Business models and Funding sources

Use of appropriated funds.

### C.20. Cost-effectiveness of energy part of the project

The cost-effectiveness of the different energy measures was calculated. (Cost-effectiveness is based on a comparison of the annual energy cost savings to the investment costs.) One metric for cost-effectiveness is net present value (NPV). Table C-5 lists the NPV for the individual energy-saving measures. The data in Table C-5 show that the only energy measures that result in a positive NPV are the replacement of the heating distribution piping and pumps and the domestic hot water pump.

Table C-5. Net present value analyses.

Energy measures	Energy-Saving Operation	Investment Cost	Maintenance Cost	Total NPV
	Euros/year	Euros	Euros/year	Euros
DH piping	725	5,915	0	19,414
Heat distribution pumps	369	1,479	0	11,058
DHW pump	74	672	0	1,322

Energy measures	Energy-Saving Operation	Investment Cost	Maintenance Cost	Total NPV
	Euros/year	Euros	Euros/year	Euros
DHW consumption	10	423	0	-588
Fresh Water consumption	748	12,099	67	-1,246
Exterior door	168	4,927	0	-5,024
Hot water piping	84	6,990	0	-7,533
Hot water tank	42	4,705	134	-9,448
Heating distribution pipe	21	14,115	134	-23,962
Loft insulated	504	65,871	0	-45,977
New windows	1,767	77,432	1,344	-93,031
Lightweight wall insulated	1,649	231,556	1,344	-209,084
Ground slab insulated	3,161	409,541	0	-284,801
MHRV	2,857	188,202	1,344	-375,097

The data in Table C-6 give an overview of the cost effectiveness of the deep energy renovation of the LARGE renovation of Bldg. 3, resulting in a total negative NPV of 696 Euros/m<sup>2</sup>. In this context, it has to be pointed out that the economic analyses have been based on the LARGE Renovation energy measures without taking into consideration RE systems. Even though the resulting NPV is negative, the LARGE Renovation scheme is more cost-efficient than demolition and new construction of a comparable building.

Table C-6. Cost effectiveness for LARGE action.

	Value
<b>Annual total energy cost savings</b>	12,178 Euros
<b>Total energy-related investment cost</b>	1,023,926 Euros
<b>Simple payback time</b>	131 years
<b>Total NPV</b>	-696 Euros/

### C.21. User evaluation

The following parameters will be measured once the building construction has been finished:

- Energy and CO<sub>2</sub> savings: Electricity consumption, water consumption, heating energy consumption, drainage reductions, actual RE-performance.
- Indoor improvements: Daylight conditions, optical conditions, temperature conditions, air quality, draughts, etc.
- User-perceived improvements (occupational health and habitation): User satisfaction, number of sick days, changes in the pattern of use (social activities and the like.).

### **Description of user training programs within the refurbishment**

Development of an app used for monitoring energy consumption is a good participative idea that can advantageously be used in other similar contexts. The app is an education performance tool to help the users learn and improve their behavior.

A wide user survey will clarify whether the users get the expected improvements, and if so, whether synergies between the initiatives occur.

### **Integration of users' demands in the planning process**

It is desired to study the extent to which the proposal requires user involvement, including how the proposed technical solutions relate to the users.

## **C.22. Experiences/Lessons learned**

The project is not finished yet and therefore it has not been possible to evaluate the final results. However, the expected outcome is described in the following sections.

### **Synergies**

The sustainability initiatives of this renovation project show synergy between visibility, climate change reductions, rainwater use, maintenance cost reductions, and employee behavior changes.

The Almegårds Kaserne project builds upon the understanding that climate adaptation and sustainability problems cannot be solved by technological solutions alone. Innovative technology solutions are crucial if we are to meet future challenges in relation to resource scarcity, increasing precipitation, and reducing CO<sub>2</sub>. However, the technological solutions must be followed by behavioral changes. The project aims to show that it is possible to create learning environments that convey an understanding of otherwise hidden correlations in relation to resource scarcity, consumption, and use of local resources.

### **Balance between environmental benefits and costs**

A good relationship between the environmental and resource benefits of the proposed solutions and the associated capital and operating costs is anticipated.

The activities provide visibility, well-being, improved employee behavior and flexibility, as well as more and better applications of the barracks' outdoor areas.

The outdoor social spaces will encourage and invite people to stay for activity and reflection. Spending time in nature has documented beneficial effects on people's general health. Outdoor areas will greatly contribute to strengthening the productivity of the employees and will be an important factor in the effort to make Almegårds Kaserne a good and healthy workplace with a focus on environmental, social and economic sustainability.

### **Impact on indoor climate quality**

The project focuses on obtaining a good indoor climate. A marked improvement in the user experience of indoor quality is expected, both by staying in and outside the

building. Thus, the new wall, by managing daylighting and eliminating overheating discomfort and drafts, effects a radical and positive change in the indoor climate. Additionally, a number of initiatives will enable each user to benefit from improved indoor environment, including sun protection from exterior shutters and passive solar shading from deciduous trees.

#### **Follow up on the renovation**

All parameters mentioned above in Section C.21. "User evaluation" are planned to be monitored after the renovation is complete in 2017.

#### **C.23. References**

1. 2012. Competition program. Green Establishments. The Defense building and Infrastructure of Denmark.
2. 2012. Requirements of Green Establishments. Brochure of Almegård Kaserne project. The Defense building and Infrastructure of Denmark.
3. 2013. Proposal reports of Almegård kaserne project. Green Establishments. The Defense building and Infrastructure of Denmark.
4. March 2014. Final proposal of Almegård kaserne project/191113. Fase II.

## Appendix D: Barracks, Presidio of Monterey, CA, USA.

### D.1. Name of the project, location

Presidio Army Barracks, Monterey, California, USA.

### D.2. Abstract

Presidio of Monterey, home to the Defense Language Institute, faces the same challenges as other Army bases in managing its aging building stock. Over 25% of the barracks, for example, were built in the 1960s and lack today's safety, comfort, and energy efficiency standards. In preparing to address the shortfalls of one such Presidio barracks, Bldg. 630, the Directorate of Public Works staff worked with the U.S. Army Corps of Engineers to chart a path forward. Rather than relying on conventional approaches to infrastructure modernization, stakeholders decided to craft the military's first documented DER solution.

The Army defines a DER as a "major building renovation project in which site EUI (including plug loads) has been reduced by at least 50% from the pre-renovation baseline, with a corresponding improvement in indoor environmental quality and comfort"[1]. For Presidio, preliminary energy modeling helped set an ambitious but achievable goal of 86% energy savings using a combination of high performance envelope requirements with super-efficient (but commercially available) HVAC and lighting systems, including solar hot water generation sized for 70% of the DHW load. Ultimately, Presidio will apply the successes and lessons learned from its first DER towards additional retrofit projects to better align with its mandated NZE trajectory. The true value, however, lies in leveraging energy savings as a part of renovation projects aimed at raising the quality of facility conditions to a level commensurate with the mission of its occupants.

The goal of this case study report is to demonstrate the acquisitions strategies employed and field lessons learned in an attempt to better guide prospective DER project stakeholders. Being a federal facility, this project employed a regimented process to various contracting phases, with some strategic augmentation to support the DER method that is transferrable to similar retrofit efforts. As a pilot effort, there have also been many process-based and technical lessons learned that can be used to bolster future DER work at Presidio, in the Army, and throughout the sustainability industry.

### D.3. Project description

Since it lacked any historical renovation efforts and was nearly 60 years old, Bldg. 630 had been flagged by Presidio Public Works staff as failing to meet current Army requirements, including modern criteria for seismic progressive collapse, fire protection, accessibility, anti-terrorism, and space management (Figure D-1). Moreover, the building suffered from inadequate ventilation, poor temperature control, and failed components. Project planning commenced in the summer of 2011 to replace the deteriorating and overcrowded gang-latrines style barracks and pursue the military's current configuration for two-person modules, common spaces, and in-



room bathrooms [2]. At nearly 65,000 ft<sup>2</sup> (6,045 m<sup>2</sup>) and over 130 kBtu/ft<sup>2</sup> (410 kWh/m<sup>2</sup>) in annual site energy usage, Bldg. 630 was one of Presidio's largest and most energy-intensive facilities. Following completion of the first wing in August 2016, soldiers will begin to reoccupy Bldg. 630 with the expectation of less than 20 kBtu/ft<sup>2</sup> (63 kWh/m<sup>2</sup>) per year in site energy usage based on contracted performance targets and additional prescriptive system requirements.

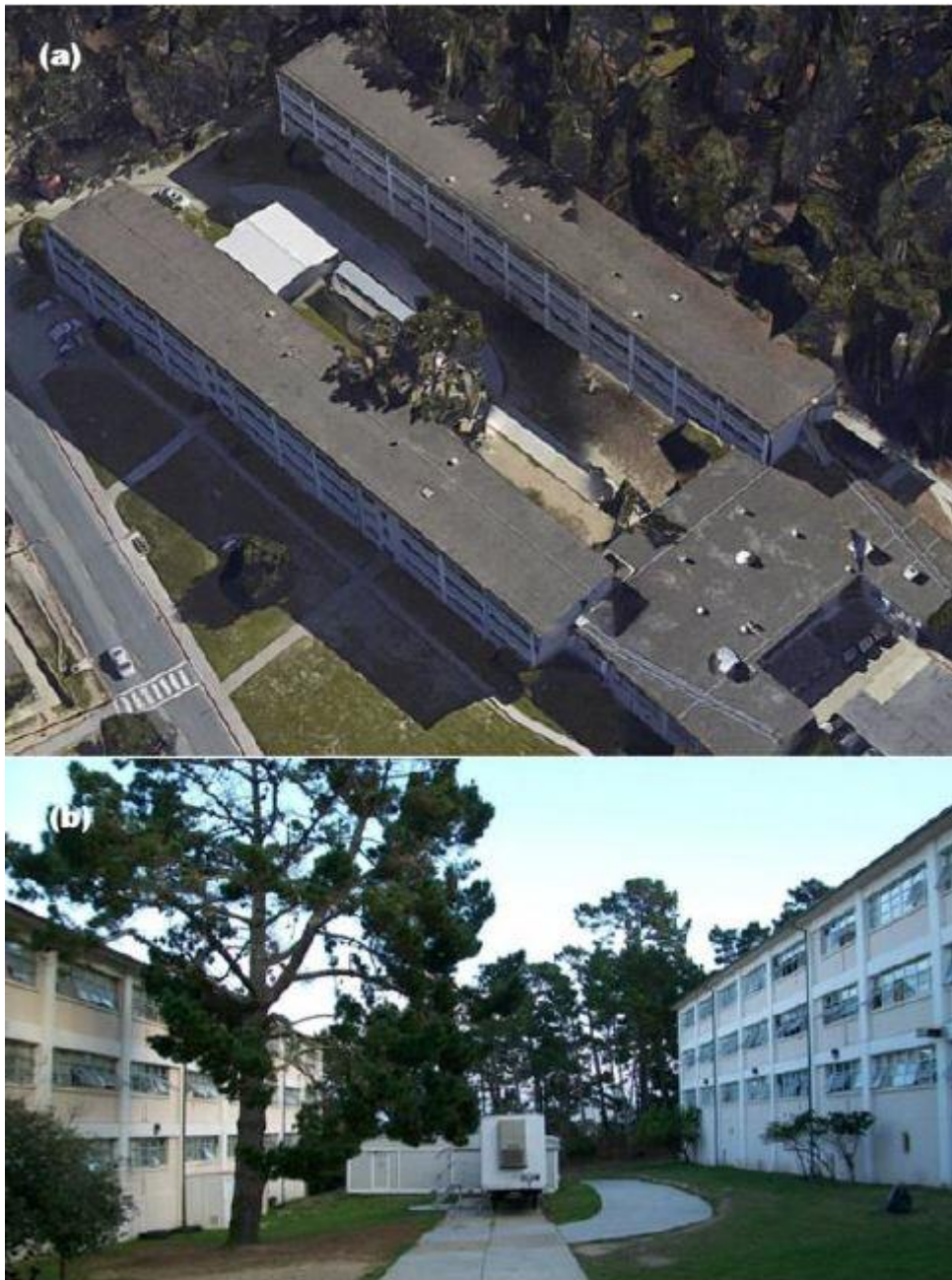

Figure D-1. (a) Bldg. 630's 3-story barracks wings (1-story connecting structure is administrative spaces that are not part of the case study), (b) uninsulated concrete masonry unit (CMU) walls and single-pane windows—typically left open year-round for ventilation—make for poor building envelope performance.

#### D.4. Existing systems

Significant energy savings were required to achieve DER reductions and comply with the 2005 Energy Policy Act (EPAAct 2005), the Energy Independence and Security Act of 2007 (EISA 2007), UFC 1-200-02 on High Performance and Sustainable Building Requirements, and current Army directives on energy efficiency. Existing building systems and their conditions at Bldg. 630 were as follows:

**Building Envelope:** The roof was a built-up gravel system over a 4-in. (102-mm) concrete substrate with no insulation. Walls and floors were uninsulated 8-in. (204-mm) concrete block and 4-in. (102-mm) concrete slabs, respectively. There was no insulation between the first floor slab and crawlspace. Windows were single-pane operable type with metal frames and no seals. Doors were uninsulated with deteriorated or non-existent weather stripping.

**HVAC:** Space heating was provided by a failing hydronic system with baseboard radiators in each bedroom, many with control valves stuck open. The radiators were manually controlled with knob-type capillary tube thermostatic controllers that lacked setbacks or feedback. Due to the absence of forced air ventilation, occupants were instructed to keep windows open daily year-round to reduce odors. Heating was typically left on all day and all year long. Hot water was supplied at 180 °F (82 °C) by a series of non-condensing, natural-gas-fired boilers, and was circulated via constant speed pumps.

**Domestic Hot Water:** DHW was supplied to the gang latrines by additional non-condensing, natural-gas-fired water heaters and a 600-gal (2,271-L) storage tank. Flow rates at shower fixtures were measured to be either 1.5 or 1.75 gallons per minute (GPM) (0.09 or 0.11 L/s). There were six showers per floor per wing. Flow rates at sink fixtures were measured to be either 1.5 or 2.2 GPM (0.09 or 0.14 L/s). The number of clothes washers and dryers was insufficient for current needs and only satisfied 30% of the demand.

**Lighting:** All built-in lighting used T8 lamps with manual switches. Each bedroom had one overhead fixture with four 4-ft (1.22-m), 32W lamps. Bedrooms also had incandescent task lighting at the desks. Each corridor had 13 fixtures, each with two 4-ft, 32W lamps. Corridor and public area lighting controls were inaccessible to occupants, which resulted in 24/7 operation of these lighting systems.

**Equipment:** The majority of the equipment load in the building was due to electrical equipment brought in by occupants. Recent years had seen an increase in personal electronics and appliances such as televisions, computers, gaming consoles, and mini-fridges. The aging electrical system was out of code and suffered from frequent tripped breakers because of the increased loads. Shared laundry equipment (washers and dryers) accounted for the balance of the equipment load.

**Utility Meters:** Presidio Public Works staff provided metered utility data for electricity, natural gas, and water. Electricity usage was metered from June through October of 2012 and then extrapolated for the rest of the year. Annual natural gas usage (Figure D-2), was available for the years 2009 through 2011 (estimated 75% used for space heating and 25% for DHW). Annual water usage was available for 2011 only.

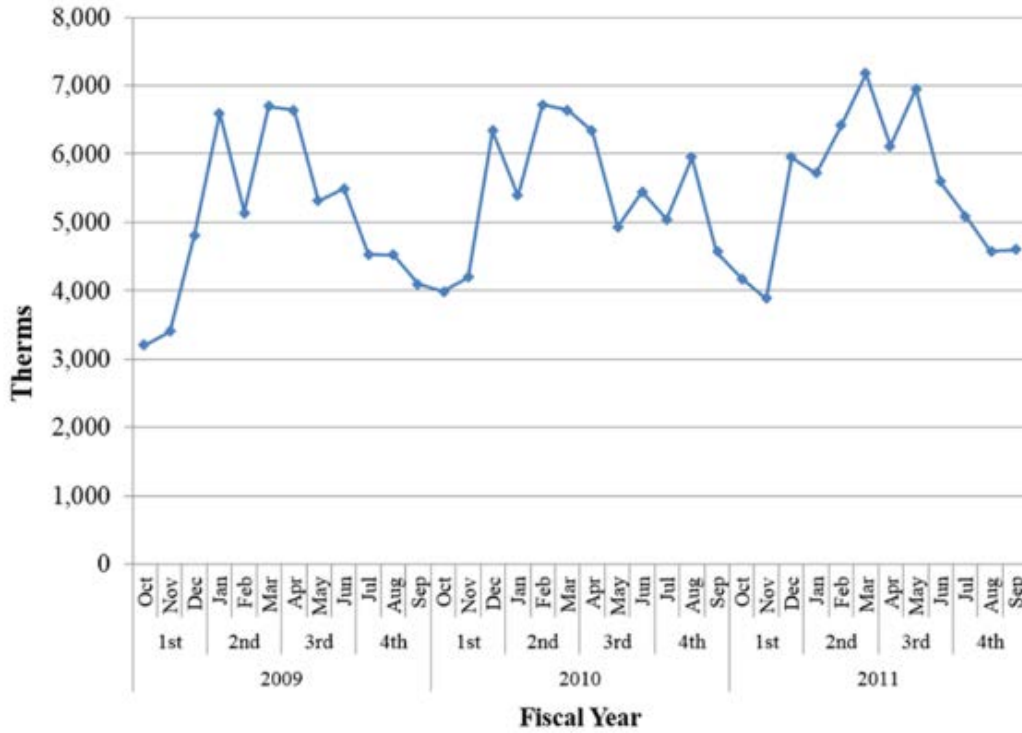

Figure D-2. Bldg. 630 Natural gas usage.

### D.5. DER systems

The project scope featured a combination of performance-based and prescriptive requirements for new building systems (see Figure D-3) to be installed after a gutting of all non-structural components.

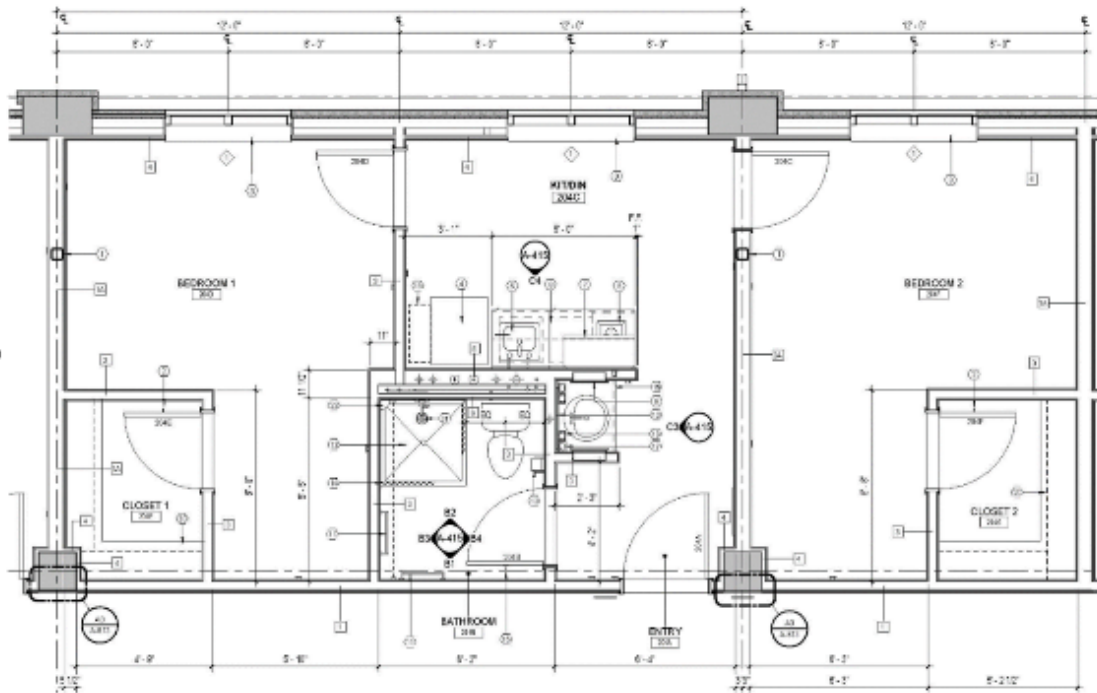

Figure D-3. The Army’s updated barracks room layouts provides more space and improved indoor environmental quality through forced air ventilation and better controllability of HVAC systems.

**Envelope:** The envelope has been upgraded to exceed the minimum requirements of ASHRAE Standard 189.1-2011 [3]. The roof was retrofitted with R-25 continuous insulation and solar hot water panel mounts. Exterior walls have been retrofitted with external R-12 continuous insulation and cladding. Windows were replaced with double-pane operable upgrades and installed with thermally broken insulated frames. Exterior doors were replaced with weather-stripped, insulated doors. The entire envelope was sealed to minimize air infiltration with a contractually-required leakage rate below 0.15 cubic feet per minute (CFM)/ft<sup>2</sup> (0.76 L/s.m<sup>2</sup>) of envelope at 75 Pa (0.011 psi) [4]. This was 40% more stringent than the standard U.S. Army Corps of Engineers (USACE) testing requirement of 0.25 CFM/ft<sup>2</sup> (1.06 L/s.m<sup>2</sup>) of envelope at 75 Pa (0.011 psi).

**HVAC:** Space heating in each bedroom is provided by low temperature, hydronic radiant heating in the ceiling space and controlled with digital thermostats. Variable flow hot water is supplied from stratified storage tanks connected to solar water heating panels and booster heat from high-efficiency condensing natural gas-fired boilers. Mechanical ventilation is delivered to each bedroom at all times at low volume from a central DOAS that includes heat recovery from exhaust air streams. As is the case for all Presidio barracks, due to Monterey's mild coastal climate, there is no space cooling except for one conference room and communications equipment closets. All systems are operated with digital HVAC controls and use graphical interfaces for configuration, programming, and trending of connected systems (Figure D-4).

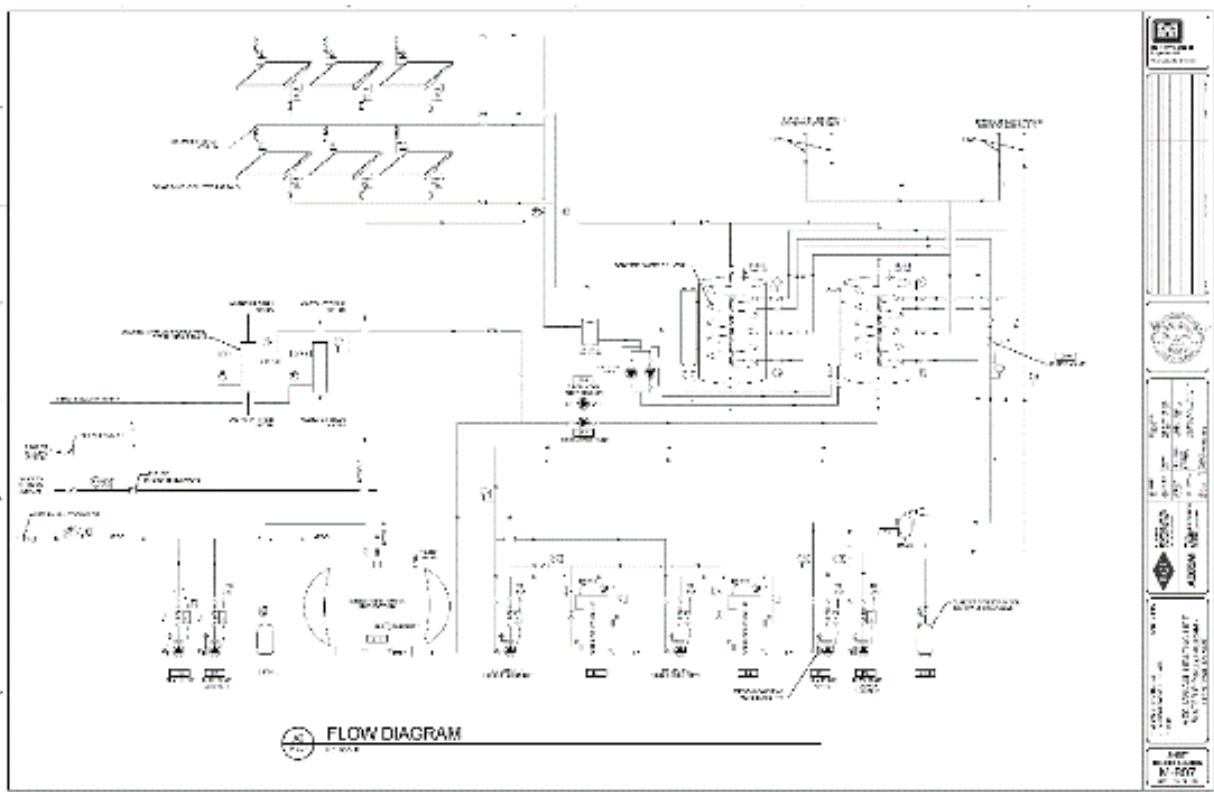

Figure D-4. Flow diagram indicating the interconnectedness of many HVAC and DHW systems.

**Domestic Hot Water:** DHW is supplied to bedroom suites for showers and sinks from a large storage tank that is preheated by greywater heat recovery from showers and solar hot water designed to provide 70% of DHW needs and space heating. Gang latrines have been converted into laundry rooms and furnished with water-saving washers; however, only one washer per laundry room is equipped for hot water usage and has been labeled “for extreme sanitation purposes only.” Greywater systems provide water for toilet flushing and irrigation. Low-flow fixtures were installed for showers and sinks. The flow diagram shown in Figure D-4 indicates the interconnectedness of many HVAC and DHW systems.

**Lighting:** All built-in lighting was replaced with T5 and T8 lamps and high-efficiency electronic ballasts. All task lighting has been updated to compact fluorescent lamps. Corridor and public area lighting controls have been replaced with occupancy sensors. Exterior lighting uses multi-level dimming LED fixtures with occupancy sensors to boost output from a 10% power standby mode to full power temporarily.

**Equipment:** ENERGY STAR-rated appliances have been provided for shared washers and room refrigerators. No other specific measures were implemented for reducing equipment loads.

**Utility Meters:** Electric and water sub-metering has been required on each floor. Electric meters use current transformers on each branch feeder allowing measurement to spaces that can be regulated by building occupants while separately measuring equipment such as communications equipment and mechanical equipment. Three water meters per floor allow for domestic cold, hot, and return monitoring (hot water return line metering is required to determine actual usage). Interval and cumulative data are available to facility management as well as to building occupants through a BAS monitoring kiosk in the lobby to foster energy and water usage awareness and competition.

## D.6. Energy modeling

Consideration for DER tactics at Bldg. 630 began in 2012 with pre-design efforts that included energy modeling. EnergyPlus modeling of Bldg. 630 (Figure D-5) helped establish the performance targets and systems to achieve DER results. Presidio investigated several retrofit packages to determine the feasibility for substantial energy reduction in pursuit of recent federal mandates. The most stringent of these mandates, EISA 2007, calls for a 65% reduction in the source energy intensity of a baseline building from the 2003 Commercial Buildings Energy Consumption Survey (CBECS) [5] by 2015. Using “Lodging - Dormitory, Fraternity, or Sorority” as the closest matching CBECS building type, post-retrofit performance is limited to a source energy usage index (EUI) of 52.5 kBtu/ft<sup>2</sup> (165 kWh/m<sup>2</sup>) – roughly a quarter of the existing source EUI (210.4 kBtu/ft<sup>2</sup> [663.14 kWh/m<sup>2</sup>]). Determining that a DER approach would be necessary to achieve such substantial energy reductions, Presidio funded the U.S. Army Engineer Research and Development Center, Construction Engineering Research Laboratory (ERDC-CERL) to support DER modeling.

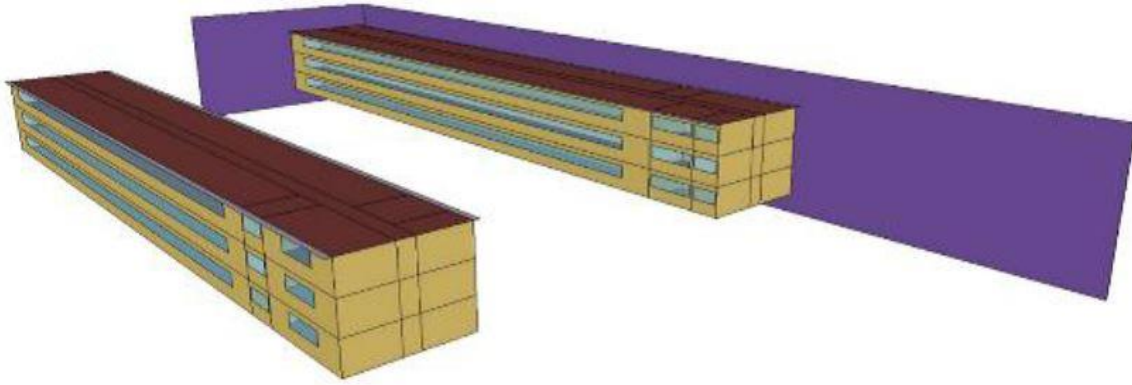

Figure D-5. Representation of EnergyPlus modeling of Bldg. 630.

Table D-1 lists DER simulation results using EnergyPlus and the parametric template tool Params developed by Big Ladder Software to automatically generate and manage model input files [6]. Bldg. 630's location and orientation were established at 36.6 N latitude, 121.9 W longitude and 47.5 degrees clockwise from North. To account for site topography, Wings A and B were modeled at 385 ft and 395 ft, respectively. Nearby trees were modeled as shaded surfaces on the building, and the adjoining Wing C that was not part of the study was modeled as an adiabatic surface. Increased infiltration to 1.5 CFM/ft<sup>2</sup> (7.62 L/s/m<sup>2</sup>) is considered as capturing the open operable windows condition. The Monterey typical meteorological year (TMY) weather file was input from the EnergyPlus website.

Table D-1. DER EnergyPlus kBtu/ft<sup>2</sup> modeling results for Bldg. 630.

	Site EUI	Source EUI	vs. Site Existing	vs. Source Existing	vs. EISA
Existing (Metered)	131.4	210.4	—	—	—
Existing (Calibrated)	131.9	210.8	—	—	—
Reduced Occupancy (250 to 150)	124.3	192.2	6%	9%	—
EISA Baseline (CBECs 2003)	58.0	150.0	56%	29%	—
Standard Retrofit (ASHRAE 90.1-2010)	40.1	96.4	70%	54%	36%
Enhanced Envelope Package	40.7	98.7	69%	53%	34%
Low Lighting Power Densities (LPD) Lighting Package	34.2	76.2	74%	64%	49%
DOAS/Radiant HVAC Package	34.0	75.7	74%	64%	50%
High-Efficiency DHW Package	31.5	73.1	76%	65%	51%
Drain Water HR Package	28.4	69.9	78%	67%	53%
Equipment Package (Plug Loads)	25.6	60.4	81%	71%	60%
Solar HW 30% Package	22.3	56.9	83%	73%	62%
Solar HW 70% Package	17.9	52.4	86%	75%	65%
EISA Target	—	52.5	—	75%	65%

Once the existing building model had been calibrated against utility data to within a 0.4% discrepancy, the reduced occupancy from 250 to 150 soldiers resulting from the Army's more spacious barracks configuration was simulated. The EISA baseline from 2003 CBECS is given in the last row of Table D-1 and is used as the common reference to calculate the relative energy savings for each retrofit package. The standard retrofit, defined as an upgrade to meet American Society of Heating, Refrigerating, and Air-Conditioning Engineers (ASHRAE) Standard 90.1-2010 performance requirements for envelope, lighting, and HVAC systems [7], contributes roughly half of the energy savings needed to achieve the EISA 2007 target. Additional retrofit packages were subsequently applied as DER measures until the 65% mandate was met.

By combining iterative effects of each of the DER measures listed and using national site-to-source conversion factors of 3.34 for electricity and 1.047 for natural gas [8], the EISA 2007 mandate (equating to an 86% reduction in site EUI) was revealed as viable. This process of energy modeling during the pre-design project phase provided Presidio with two key deliverables: realistic DER performance targets for Bldg. 630 and a list of facility system parameters to attain them.

#### **D.7. Cost estimating**

As part of the project funding request to the Army, Presidio was required to demonstrate the cost effectiveness of the DER approach when compared to a default new construction method, in accordance with Army Regulation 420-1, Chapter 2 [9]. The USACE Sacramento District took the lead on cost comparisons using the Parametric Cost Engineering System (PACES). According to these government cost estimates, the DER-to-replacement value for Bldg. 630 using facility systems identified in the energy model was calculated at 54% [10]. This means that the cost of renovating the building to meet the DER energy use targets was about half of what the cost would be to demolish Bldg. 630 and build a new barracks to meet ASHRAE Standard 90.1-2010 performance requirements.

Much of the cost savings is tied to the tremendous amount of demolition, site-work, and structural-work avoided by renovating instead of tearing down and building anew (Figure D-6). The same level of HAZMAT abatement would have been required in either case to remove the asbestos found in interior wall boards. Avoiding various site demolition and building foundation/shell construction actions for the three-story, 65,000 ft<sup>2</sup> (6,045 m<sup>2</sup>) facility, however, was estimated as saving on the order of \$10 million in related project funds. This does not account for the conserved natural capital associated with the new concrete material, additional construction equipment emissions, and increased storm water and site degradation that would result from a demolition/new construction project.



Figure D-6. Guttied exterior (a) and the interior (b) of Bldg. 630.

### D.8. Schedule and first cost savings

Due to the constrained land area of the Presidio of Monterey, there are no “green field” sites. This means that, for projects at the Presidio, any work involving earth-moving activities have typically incurred unforeseen costs and delays. This is due to three primary reasons: unforeseen cultural/historical artifacts uncovered on the site, unforeseen underground utilities, and stringent stormwater regulations. An example is Presidio’s Dining Facility Project, which started a year before the 630 Barracks Project, but encountered major delays due to storms and unforeseen underground utilities. The Dining Facility project is only 60% complete, compared to Bldg. 630, which is 95% complete at the time of this writing. The advantage of a renovation is that the concrete structure is already in place. Additionally, most of the underground utility lines are in place.

There are extra costs associated with a DER renovation relative to one that meets ASHRAE Standard 90.1-2010 performance requirements; however, these costs are minimized for two reasons. First, many ECMs can be enhanced to a DER level by adding some fractional purchase costs at no additional labor. For example, the labor and scaffolding equipment are major costs associated with mounting external building insulation in standard retrofit project. But increasing the insulation to a DER level could be done for only the added material price for R-12 insulation over the cost of conventional R-7.6 insulation, adding only about 7% to the total installed cost of external insulation.

Second, several DER measures were found to require less initial investment if they reduced electric or space conditioning (HVAC) demand to the point where the building’s systems required smaller equipment or component sizes. One example of this type of first cost saving was with the new hot water boilers. The enhanced envelope design contributed to load reductions that allowed two high-efficiency 500 kBtuh (136 kW) boilers to replace the five existing conventional 1,000 kBtuh (293 kW) boilers. The total initial cost of the DER measure is estimated to be 23% less than the standard retrofit cost. Table D-2 summarizes the cost breakdowns for these ECMs using RSMeans® [12] equipment cost estimates associated with these two levels of insulation.



Table D-2. Cost breakdown for example DER measure yielding net first cost savings.

	Quantity	Unit	Material	Labor	Equipment	Indirect Factor	Total Costs
<b>Wall Insulation</b>							
Existing (None)	0	ft <sup>2</sup>	–	–	–	–	–
Standard Retrofit, R-7.6	45,000 (4,185)	ft <sup>2</sup> (m <sup>2</sup> )	\$2.05	\$2.29	\$2.01	19.8%	\$342,800
DER, R-12 (Installed)	45,000 (4,185)	ft <sup>2</sup> (m <sup>2</sup> )	\$2.49	\$2.29	\$2.01	19.8%	\$366,300 <i>7% increase</i>
<b>Hot Water Boilers</b>							
Existing (1,000 kBtuh)	5	ea.	–	–	–	–	–
Standard Retrofit (750 kBtuh)	4	ea.	\$41,900	\$21,000	–	19.8%	\$301,300
DER (500 kBtuh, Installed)	2	ea.	\$34,600	\$19,700	–	19.8%	\$129,900 <i>57% savings</i>
<b>Cost of Combined ECMs</b>							
Standard Retrofit	\$644,100						
DER Retrofit	\$496,200 <i>23% net savings</i>						

USACE reported some of the major project costs elements as follows:

1. Total project  $\approx$  \$ 23,700k.
2. Graywater option  $\approx$  \$ 600k (included in \$23.7M project total).
3. Rooftop solar thermal awarded: \$420k (included in \$23.7M project total).
4. Non-DER costs for design, parking/hardscape changes, additional rooms  $\approx$  \$6,850k (included in \$23.7M project total).
5. Additional incremental DER costs < 10% of remaining project costs (\$23.7M – \$7.87M) < \$1.583M.
6. Total estimated DER costs  $\approx$  #3 + #5 above = \$0.42 + \$1.583M = \$2.003M.

Therefore, the estimated incremental costs to reduce EUI from 40.1 kBtu/ft<sup>2</sup>-yr (the required EUI) to 26 kBtu/ft<sup>2</sup>-yr (the predicted EUI after DER retrofit) was about \$2,000,000 (8.5% of total project costs). This results in the additional investment cost over that required to achieve minimum EUI standards being about \$30/ft<sup>2</sup> (\$330/m<sup>2</sup>).

USACE did not report energy tariffs, but the avoided costs of the additional energy savings can be estimated using the local (Monterey, CA) electric tariff for commercial customers of \$0.1408/kWh. Therefore, the predicted cost effectiveness of the

investment for reducing EUI below Army minimum requirements (additional 14.1 kBtu/ft<sup>2</sup>-yr = 4.5 kWh/ft<sup>2</sup>-yr = 48.25 kWh/m<sup>2</sup>-yr EUI improvement from DER measures) can be estimated to be about \$0.63/ft<sup>2</sup>-yr (\$6.80/m<sup>2</sup>-yr).

## D.9. Funding

The project was funded with Sustainment, Restoration, and Modernization (SRM). SRM funds are those budgeted for planned renovation of a structure. An alternative funding strategy was considered that would have supplemented SRM funds for a standard retrofit with financing from an ESPC. The benefits of this approach would have included limiting Army funding requests to conventional amounts, delegating advanced energy-saving tasks to a specialized contractor, and using utility bills to pay back the incremental DER costs. Though Bldg. 630 was fully funded for the project and did not require third party financing supplementation, the ESPC approach remains a potential strategy for achieving DER in future projects.

## D.10. RFP requirements

In 2011, Presidio funded USACE Sacramento District to develop an RFP to outline project requirements for Bldg. 630's DER approach. A planning charrette was conducted shortly thereafter with a team of designers and stakeholders who gathered the information needed to develop a 10% concept design. The Presidio Department of Public Works (DPW) staff provided a written Owner's Project Requirements (OPR) document (see Table D-3) and the results of ERDC-CERL's energy modeling to help define the goals of the project and how to accomplish them. Due to the emphasis on energy and water savings, the RFP was iteratively refined and reviewed over the course of the following year to ensure that quantitative system performance targets were sufficiently specified and complemented by adequate prescriptive instruction where necessary. The writing of the RFP was the most time-consuming part of the pre-award steps. Since they were breaking new ground, the DPW/USACE team spent months writing and revising the specification's Section 011000, especially the mechanical, plumbing, electrical, HVAC controls, and energy conservation sections.

Table D-3. Summary of key energy system performance requirements in the RFP.

Performance Parameter	Existing Building	Reduced Occupancy	Standard Retrofit	DER Requirements
Occupants	228	150	150	150
Roof Insulation	R-0	R-0	R-20	R-25
Wall Insulation	R-0	R-0	R-7.6	R-12
Window U-Value	U-1.27	U-1.27	U-0.65	U-0.40
Window Solar Heat Gain Coefficient (SHGC)	0.85	0.85	0.25	0.25
Infiltration At 75 Pa (CFM/Ft <sup>2</sup> [L/S/m <sup>2</sup> ])	1.5 (7.62)	1.5 (7.62)	0.6 (3.05)	0.15 (0.76)
Lighting Power Density (W/Ft <sup>2</sup> [W/m <sup>2</sup> ])				
Bedroom	1.15 (0.35)	1.15 (0.35)	1.1 (0.34)	0.6 (0.18)
Corridor	0.82 (0.25)	0.82 (0.25)	0.5 (0.15)	0.35 (0.11)

Performance Parameter	Existing Building	Reduced Occupancy	Standard Retrofit	DER Requirements
Stair	1.0 (0.3)	1.0 (0.3)	0.6 (0.18)	0.29 (0.09)
Equipment Power Density (W/Ft <sup>2</sup> [W/m <sup>2</sup> ])	1.75 (0.53)	1.15 (0.35)	1.15 (0.35)	0.86 (0.26)
HVAC System Type	HW Radiator	HW Radiator	DOAS/Radiant	DOAS/Radiant
Zone Thermostat Control	No	No	Yes	Yes
Variable Speed Pumps	No	No	Yes	Yes
Hot Water Temperature Reset	No	No	Yes	Yes
Condensing Boiler/Water Heater	No	No	No	Yes
Drain Water Heat Recovery	No	No	No	Yes
Mechanical Ventilation	No	No	Yes	Yes
Operable Windows	Yes	Yes	Yes	Yes

### D.11. Design methodology

The Presidio pursued a Design-Build (DB) approach for the project instead of Design-Bid-Build (DBB). This was done for four reasons:

- **Design Funding Constraints:** Since there was no guarantee that the project would be funded, Presidio did not want to pay for a full design, which would have cost from \$1 to 1.5 million. The cost to develop the DB RFP was \$450k.
- **Timing Constraints:** A full DBB would have taken over a year. Even if the funding had been provided on October 1, getting a full design done in-house by early Spring (to allow for an adequate solicitation and award time to meet the September 30th deadline) would have been very difficult.
- **Technical Expertise Constraints:** Since this was to be the most ambitious energy project done at the Presidio, there was a desire to take advantage of the industry's expertise. The intent was to set stringent performance requirements and allow the contractor to design and build a solution. One major advantage of DB over DBB is that the contractor "owns" the design and is thus not likely to pursue design-related change orders. Because the project was pushing new boundaries with energy and water goals, the government team chose to minimize risk through the DB approach.
- **Renovation Constraints:** Because the project was a renovation of an existing building, developing an exact design would be very challenging. Floor-to-ceiling heights were a major constraint; seismic retrofits would depend on field conditions; fire sprinkler design would have to work around existing rooms in Wing C; and a mechanical room would have to stay in operation during Phase 1 since Wing A was still occupied while Wing B was under construction. Putting the onus of design on the contractor relieved the government from major risk of change orders while giving the contractor design ownership.

The decision to go with a DB approach has yielded the following additional benefits:

- **Reduced Change Orders:** the "Request for Information" (RFI) and change order rate on

this project have been estimated at less than half of that from recent DBB projects and freed up the Architect/Engineering contractor to provide creative solutions to unforeseen challenges.

- Improved Room Layout: The RFP required 150 rooms to be provided. This was based on the 10% concept design done by USACE. Based on Fire Code, USACE determined that a third stairwell would be needed to meet the egress distance requirements. Due in part to the flexibility of the DB method however, the contractor determined a way to design the room layout so that the third stairwell was not needed. This saved money, time, and freed up space in the building so that the Army will be able to add an additional eight rooms for a 5.3% increase in personnel at an estimated less than 1% impact to the EUI performance target.
- HVAC Solutions: The low clearances from interior concrete beams represented a design challenge, especially for the ventilation system. The contractor devised a solution with rooftop DOAS units and the primary ductwork outside the building in the external insulated chases. Fire dampers at entry points posed an additional challenge, but were overcome through precise three-dimensional modeling.

#### **D.12. Contract solicitation and award**

A Multiple Award Task Order Contract was in place with the USACE Huntsville office. This was an ideal contract vehicle since there was a pre-qualified list of contractors who had past experience with these types of contracts. This allowed the award process to go much faster than if the contract had gone to full and open competition.

Still, the Presidio wanted to request some additional evaluation criteria in the RFP intended to guide the Source Selection Board in the selection process. Criteria, which included DER experience, energy modeling approach, and greywater system knowledge, were intended to avoid contractor selection based solely on low cost. Including technical rating criteria should be considered a best practice for DER contract award.

#### **D.13. Lessons learned**

##### **Quality Assurance**

An enhanced QA process is needed to ensure that critical DER milestones are achieved. Given the advanced technologies and more stringent performance requirements associated with this project, standard QA and commissioning methods have at times been insufficient. A more comprehensive and deliverables-based approach known as Product Delivery Quality Assurance (PDQA) is recommended [12]. The PDQA process recognizes the need for evaluation criteria specific to DER projects and is comprised of five phases as defined in Table D-4.

Table D-4. PDQA used to identify roles and responsibilities associated with DER milestones.

<b>Product Delivery Phase</b>	<b>Description</b>
<b>Development Phase</b>	Clear and concise documentation of RFP, energy modeling reports, and OPR that formalize DER expectations into biddable project requirements to be references throughout the product delivery phases
<b>Procurement Phase</b>	Clear and concise documentation of RFP, energy modeling reports, and OPR that formalize DER expectations into biddable project requirements to be references throughout the product delivery phases
<b>Design Phase</b>	A whole building design approach to meet the prescriptive and performance-based project requirements outlined and with additional deliverables including energy modeling to verify performance targets at each design iteration
<b>Construction Phase</b>	Enhanced construction QA from government staff trained and experienced in DER-type construction and independent commissioning specialists engaged throughout project phases to enforcing DER-specific deliverables
<b>Post-Occupancy Phase</b>	Evaluation of energy and comfort criteria established at the development phase at predetermined intervals after occupation to verify project performance goals are being continuously met

An example of a PDQA task that is additional to standard construction project deliverables but beneficial to the DER approach is the jobsite window mock-up shown in Figure D-7. This deliverable can be considered a critical milestone in ensuring that enhanced envelope air tightness and thermal leakage performance requirements are met by allowing all QA personnel the opportunity to review or approve the mock-up version. In this way, fenestration product or installation deficiencies can be identified in the mock-up rather than with all windows in place during subsequent inspection and testing. While Presidio formalized this requirement in the project RFP, a lesson learned involved how to best use the mock-up. While the mock-up clearly showed the QA staff that backer rod and sealant were elements of the air barrier, Bldg. 630 design drawings did not include appropriate sealing methods. Additional RFP requirements on how to best construct and use the window mock-up are required for future DER RFPs, including sealing methods, exposed section layers for QA transparency, and commissioning team validation of mock-up assembly prior to window installations.



Figure D-7. PDQA process deliverables such as window mock-ups can be effective QA tools when used correctly.

### **Prescriptive RFP content**

Several DER features at Bldg. 630 may have benefited from shifting the balance towards more prescriptive and less performance-based RFP requirements. Similar to the requirement for specific HVAC system types that were determined to meet energy targets and base maintenance preferences, other areas of the RFP could have been expanded to cover system features known to be desirable for Presidio. Interior lighting technology, for example, would have better aligned with campus retrofit efforts if interior LED fixtures had been specified, just as bi-level dimming LEDs were required for exterior fixtures. Similarly, the RFP could have defined electrical circuits supporting critical vs. non-critical loads to best facilitate future power generation efforts or integration of load management technologies such as addressable receptacles. Table D-5 summarizes some of these system-specific considerations when including prescriptive RFP content for DER projects.

Table D-5. Summary of prescriptive RFP consideration for DER projects.

DER System	Presidio RFP Approach	Future RFP Considerations
<b>Greywater Tank Sizing</b>	Tank size required was estimated at 2,000 gallons based on initial calculations of 4,000 gallons per day of greywater.	For bidding clarity, either specify tank sizing or provide all sizing assumptions to be used including domestic water usage profiles, gender ratios, showering times, and whether to include washing machines.
<b>Solar Thermal System Sizing</b>	Requirement to meet 70% of DHW load based on 20 gallons per person of 120 °F supply and 140 °F storage at 10 minute shower durations.	Include additional modeling assumptions such as horizontal irradiance available, tilt angle, panel load temperatures, and DHW diversity or total daily load expected. Include DER QA team members experienced in RE modeling programs such as RETscreen.
<b>Window Type</b>	Requirement for dual pane thermally broken windows with U-value less than or equal to 0.30.	Be specific with how U-value is determined. Without specifying center-of-glass U-value vs. assembly U-value, poorer than expected window performance may be provided.
<b>Window Details</b>	Requirement for air tightness maximums and procedures, however no window details provided.	Provide window details to more prescriptively indicate air barrier and thermal break components to be later used during window mock-up QA.
<b>Interior Lighting Type</b>	LPD and foot-candles requirements provided for each space type with some exterior lighting technologies required.	If other organizational buildings are transitioning to interior linear tube LEDs as is Presidio, require this technology in the RFP in addition to LPD and illuminance requirements.
<b>Non-Critical Electric Loads</b>	Only emergency circuit criteria provided.	For load shedding or on-site power generation goals, consider requiring differentiation between critical and non-critical electric circuits.
<b>Radiant Heating Systems</b>	Requirement for overhead hydronic radiant heating in dwelling unit ceiling. No requirement given for imbedded vs. radiant panels.	Radiant systems paired with dedicated outside air units can accommodate low ceiling spaces in tighter renovation projects. Imbedded vs. paneled radiant systems have implications on hydronic distribution sizing, occupant comfort, and maintenance access.
<b>Ductwork Type</b>	ASHRAE Standard 90.1-2010 performance criteria, ASHRAE Advanced Energy Design Guide recommendations, UFGS 23 05 93 testing requirements provided. No requirement for round vs. square duct provided.	Duct leakage test requirements at Bldg. 630 were eventually met using an aerosol interior duct sealant. Consider specifying round duct for first cost savings and better leakage test results.
<b>HVAC Controls Sequences</b>	Requirements for duct static pressure, mixed air temperature, and hot water temperature set-point resets. Requirements for demand controlled ventilation and recirculation pump scheduling.	Consult with maintenance team to limit sequence of operation complexity to strategies that are applicable, desired, and supportable. Consider including requirements for special commissioning trend intervals to assist QA of advanced sequences or even providing points schedules to be completed by contractor.

DER System	Presidio RFP Approach	Future RFP Considerations
<b>HVAC Controls Infrastructure</b>	Requirements given for integration into planned campus front-end. Change order was required to establish temporary building-level front-end.	Select open protocols that support all sequences of operation. Ensure RFP includes requirements for local interfaces to accommodate testing and maintenance of the controls system.
<b>Energy Sub-metering</b>	Floor-by-floor water and electricity metering requirement for tracking and energy awareness purposes.	Specify metering intervals required (i.e., 15 minutes) and provide details on any monitoring kiosks in the building. Hot water metering may require three flow meters to calculate usage: domestic cold, domestic hot, and domestic return.
<b>Heat Recovery: Air-Side</b>	Requirement for air-side heat recovery without cross-leakage.	Cite ASHRAE Standard 62.1 to specify cross-leakage rates. Require control sequences to enable heat recovery based on outside air or space demand criteria.
<b>Heat Recovery: DHW</b>	Requirement for drain water heat recovery system on showers to preheat cold water supply. No requirements on piping configurations.	Ensure vertical space is available for drain water systems and specify insulation requirements in crawlspaces. Specify parallel piped heat recovery devices, whether bypass loops are acceptable, and how to enable bypass pumps.

One particular challenge for Bldg. 630 has been the acquisition of a BAS. This is another area where more specific RFP language could have avoided disturbances during the construction phase and better accommodated Presidio's BAS needs. Originally relying on a campus-wide management system that was not ready for connection to Bldg. 630, the DER contract had to be modified to allow temporary standalone functionality. In hindsight and commensurate with the importance of a robust and reliable BAS, a better approach would have required building-level controls that met project needs for fine interval commissioning trends, adequate operational memory, and informational energy sub-meter displays in corridors while using separate contract means to later integrate to the base-wide front-end when ready.

Yet many of the issues encountered were more foundational and came down to basic disagreements with the A-E designer on their RFP-required energy modeling. The RFP required the contractor to demonstrate that minimum EUI targets were met at each design iteration; however, much of what contributed to the EUI calculation was unclear. Thus slight differences about which square footage values were applicable, what weather files were selected, whether to remove laundry hot water usage, and how to adjust the site-to-source factors to match utility generation sources rendered energy modeling comparisons somewhat less valuable. For future projects, it is recommended to either specify each known modeling constraint in the RFP along with the performance targets, or to use the pre-design model to list each of the prescriptive requirements for system selection and operation without mandating additional energy modeling from the contractor.

#### **Additional drawing and details**

Despite the substantial effort defining RFP requirements, there were still issues with



the design team's interpretation of what was needed that additional drawings or details could have mitigated. There is a need to clarify in the RFP what is required for an air barrier shop drawing, and how the subcontractor(s) installing the various components of the air barrier must demonstrate compliance with the shop drawings. More specifically, there is a need to improve the specification for the detailing and installation of window systems. A combination of written requirements and prohibitions coupled with clear drawings of acceptable examples should be included in future RFPs. For example, the use of caulk as a component of the air barrier should be prohibited in writing. The use of positive seals with tape between the window system and the rough opening should also be explicitly stated and shown in example details. Requirements for window systems such as U-values (for the window system, not the glass) should be clear and non-ambiguous in the specification. If slider windows are not desired by the government, then that should be explicitly stated. (One note on this subject is that Presidio maintenance crews are much more in favor of sliders than casement windows due to their concern about constant repairs. Awning windows may be another low-maintenance window that provides better air sealing than sliders).

Improvements to the existing air barrier design include air barrier testing such as blower door tests as prescribed in USACE air tightness testing procedures, application of paint-on air barriers at the window, and improved window details. These drawings are needed to identify additional thermal barrier, air barrier, and installation requirements that could have prevented issues such as the later attempted use of caulking as an air barrier product (Figure D-8).

Clarity on thermal bridging requirements should also be improved with additional drawings that standardize DER approaches to balancing the additional cost of less thermal bridging with the energy penalty incurred from bridging. Structural thermal isolation pads between the building structure and exterior steel stairs should be required, whereas isolating basement staircases or bringing exterior insulation several feet below grade may require an LCC analysis and other evaluation methodologies to determine economic viability. Thermal bridging to the earth for renovations, which is especially challenging due to the cost and impact of disturbing earth along an existing foundation wall, typifies the need for improved clarity on continuous insulation requirements. Bldg. 630's RFP required insulation to be in compliance with ASHRAE Standard 189.1-2011. This code included references that did not require exterior insulation below the grade. If insulation should continue below grade to the top of the footing, it should be explicitly stated in the RFP.

Additionally, the methods used to install exterior insulation should be clarified. Rasping of rigid foam is a method used to smooth joints between panels. This method is labor intensive and causes tiny Styrofoam particles to scatter down to the ground and potentially off the jobsite. This was particularly problematic at Presidio where the storm water has the potential to carry stray Styrofoam particles from the hillside campus into the nearby marine sanctuary. As a best practice, DER RFPs should prohibit on-site rasping, shaving, sanding, or shaping the rigid foam after installation.

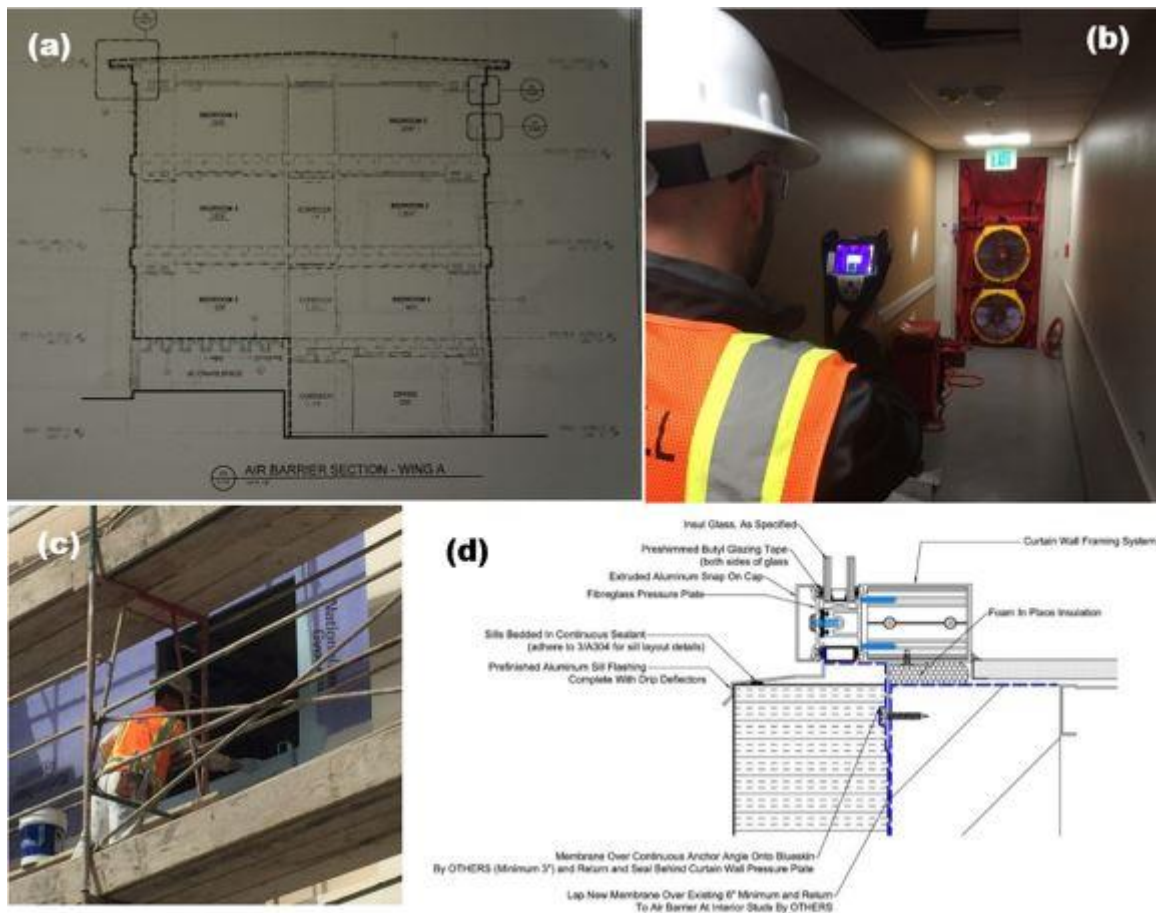

Figure D-8. Improvements to the existing air barrier design drawing (a) required: (b) air barrier testing, (c) paint-on air barriers at the window, and (d) improved window details.

In the RFP development, the government team envisioned using round or oval ducts since those have the lowest leakage characteristics. But due to very tight clearances from floor to ceiling, and to allow the transitions from the exterior shaft to the inside, the contractor opted for rectangular duct. During duct air leakage testing (DALT), the performance criteria of 3 CFM of leakage per ft<sup>2</sup> (15.24 L/s/m<sup>2</sup>) of ducting was initially not met. Ductwork joint seals alone were not enough to meet DALT criteria Standard-2011 (Figure D-9). After trying to seal joints and connections that were accessible from the outside, the contractor still could not meet the requirement. Eventually, they used an aerosol gel system that sealed from the inside. The whole process delayed the project and cost the contractor extra money. Future RFPs will benefit from clarification on leakage class ratings for round vs. square ducts, a requirement for immediate ductwork testing prior to sheetrock installation, and additional information on DALT testing procedures to include limitations on duct section lengths tested and QA sample rates.



Figure D-9. Ductwork joint seals (a) alone that did not meet DALT criteria; insulation provided (b).

For complex HVAC system configurations, system diagrams can be extremely valuable tools that schematically untangle otherwise disordered HVAC layouts to identify key system components and their interactions. Although system diagrams were not required for the Bldg. 630 design, Presidio Public Works staff drafted the design shown in Figure D-10 in an attempt to better discuss design issues discovered in the flow diagram plan sheet shown in Figure D-4. The original hydronic flow diagram, while itself a diagrammatic simplification of the building's complex piping infrastructure, does not easily support certain design review tasks. In this case, reorganizing the chaotic flow diagram into the more familiar primary dual-secondary configuration made several design errors related to flow control immediately evident. System diagrams simplify complex piping schematics and can serve as valuable communication and diagnostic tools (Figure D-10). Presidio Public Works plans to add system diagram submittal requirements for all hydronic systems in future DER projects.

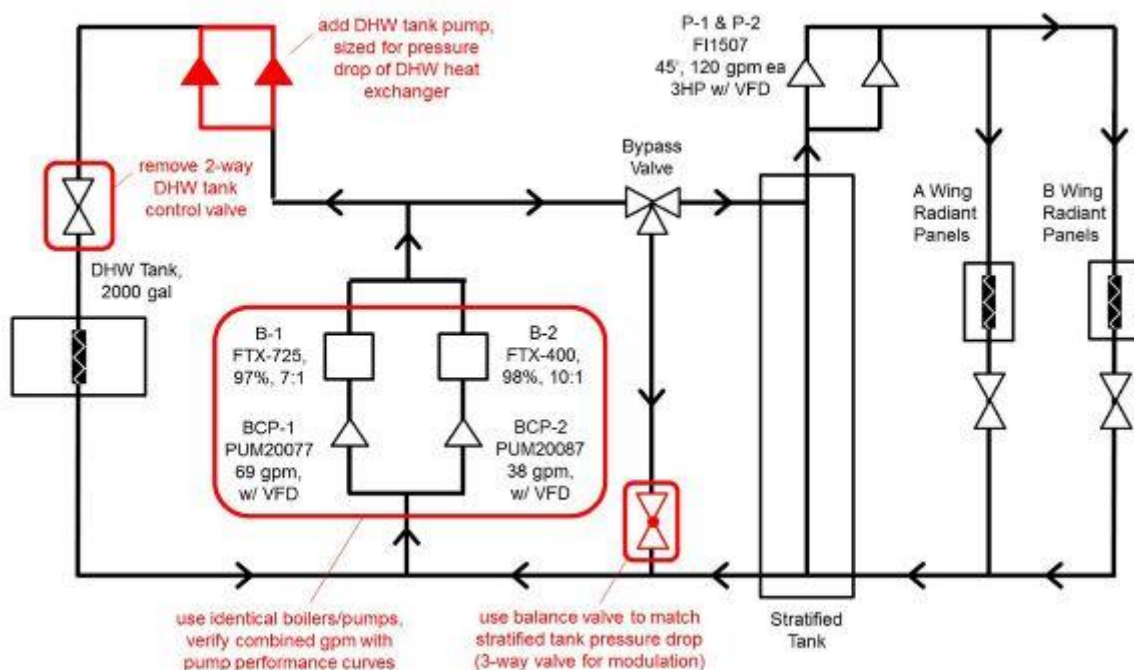

Figure D-10. System diagram of Bldg. 630's closed loop hydronic system (design errors shown in red).

## Construction phase improvements

Many buildings to be renovated will contain HAZMAT. A good process to identify HAZMAT in the RFP will lead to more accurate estimates by the bidders and fewer change orders. For Bldg. 630, DPW contracted for sampling and analysis during the RFP development. Asbestos samples were taken in both wings at floor tiles and base boards; however wallboard material samples were not taken. This was because the walls of Wing B, where the site walk was held, were CMU and would not contain asbestos. But Wing A was built about 5 years after Wing B and used wallboard. The lesson here was to do a better job in determining where to take samples.

Another challenge with renovations is delineating the project boundaries. In the 630 Barracks project, Wing C was not in the project scope, with the exception of fire sprinklers. However, because the boilers that were being replaced in the project also provided hot water to Wing C's heating system, an additional project was needed to provide heat to Wing C. Since Wing C was not in the project, its electrical loads were not initially counted. This led to concerns with the sizing of the main electrical panels and almost required upsizing the building's transformer. With respect to DER projects, defining energy boundaries is especially important since the energy intensity target was a performance specification, and the potential for dual funding from ESPCs may introduce additional collocating of on-site trades.

While building and duct air tightness requirements have been met [4] (Table D-6), there is still room for improvement. Individual areas (windows and roof) showed slight leakage and may merit increased construction attention for future DER projects. Slight air leakage was found at the roof line overhang that could be further minimized by closer adherence to the design details (Figure D-11a,b) and improved continuous air barrier application. At windows, thermal imaging and smoke testing revealed additional slight air leakage (Figure D-11c,d) and missing weep covers that have since been installed. Though not drastic enough to prevent successful air barrier testing, certain areas of localized leakage, such as that at windows, represent valuable lessons learned. Exterior stairwells, while designed to minimize the contact between the envelope and steel supports, still showed heat transfer bridging at this reduced interface (Figure D-11e,f) during testing that could have been further reduced with the installation of a thermal break. Another area of slight performance loss was at interior ducting where ASHRAE Standard 189.1-2011 levels of insulation were provided per the RFP, but had been compressed to accommodate low ceilings.

Table D-6. Tightness requirements for the first wing were met, but individual areas (windows and roof) showed slight leakage.

	Required	Pressurization	Depressurization	Combined Average	Pass/Fail
Actual Leakage (CFM [m <sup>3</sup> /min]) at 75 Pa	< 11,578 (< 324.18401)	6978 (195)	7276 (204)	7127 (200)	PASS
Actual Leakage Rate (CFM/ft <sup>2</sup> [L/s/m <sup>2</sup> ]) at 75 Pa	0.15 (0.76)	0.09 (0.46)	0.48 (0.094)	0.092 (0.47)	PASS

	Required	Pressurization	Depressurization	Combined Average	Pass/Fail
Effective Leakage Area (ft <sup>2</sup> [m <sup>2</sup> ]) at 75 Pa	—	5.3 (0.49)	5.5 (0.51)	5.4 (0.50)	—
Pressure Exponent (n)	0.45 < n < 0.8	0.720	0.639	0.680	PASS
Air Leakage Coefficient (CFM/Pa <sup>n</sup> [L/s/Pa])	—	311.7 (147)	461.0 (218)	386.3 (182)	—
Squared Correlation Coefficient	R <sup>2</sup> > 0.98	0.9988	0.9975	0.9982	PASS

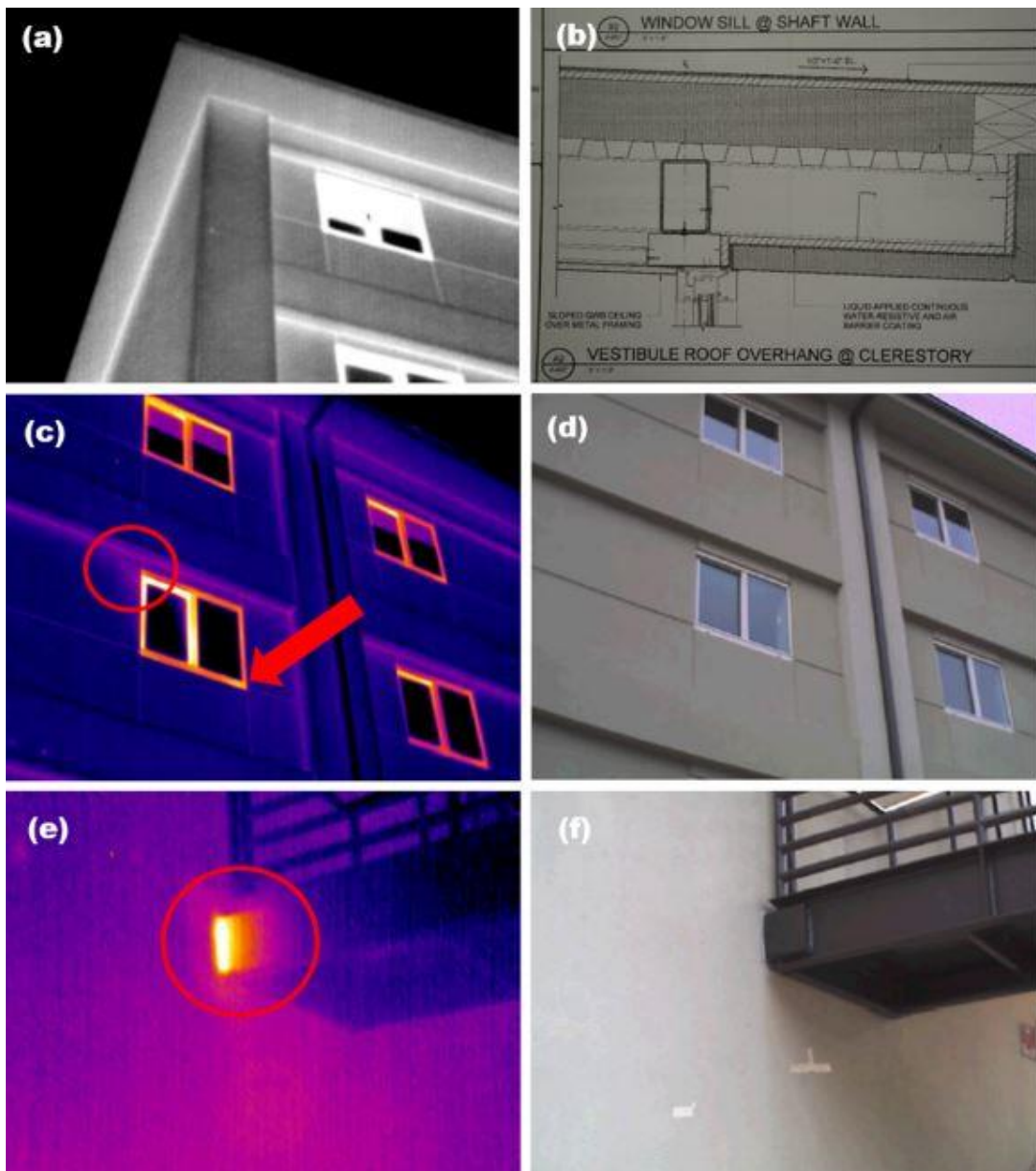

Figure D-11. Areas for improvement: (a,b) roof air barrier detail as compared was included in the design, (c,d) slight leakage at the overhang, (e,f) contact of thermal barrier and exterior stairway steel supports still acts as thermal bridge.

#### D.14. Conclusions and recommendations

By coordinating the DER of its Army barracks with a scheduled renovation to modern living standards, Presidio has established a cost-effective method for procuring high performance buildings in pursuit of its NZE goals and at shared costs. With the completion of the first wing at Bldg. 630 (Figure D-12), Presidio has accumulated a number of best practices and lessons learned to support future DER endeavors within the Department of Defense (DoD).

Table D-5 summarizes lessons learned by indicating where more prescriptive design and construction criteria are recommended in future DER projects. Additional recommendations include the need for better DER QA documentation and training, as well as standardized guidance on sizing DER systems such as solar thermal and greywater storage systems. The QA process itself needs to extend to all project phases, from commissioning and subject matter expert input during RFP development to post-occupancy performance data evaluation and remediation during the warranty period. The Army team recommends that a Center of Expertise be established to house experienced architects, engineers, and technicians that can better support DER RFP standardization, critical QA milestone acceptance, and the transitioning of applicable non-U.S. approaches, best practices, and technologies to Army projects.

Because the building was scheduled for occupation in the fall of 2016, only very preliminary post-retrofit metered data are available at this time. Those metered data in the first few months of occupancy shows the total EUI at 40 kBtu/ft<sup>2</sup> (126 kWh/m<sup>2</sup>). The EUI included 26.5 kBtu/ft<sup>2</sup> for gas and 13.4 kBtu/ft<sup>2</sup> for electrical. This is higher than was expected. A major factor is that the solar thermal DHW system is not fully operational yet; it is producing only 10% of the expected DHW load instead of 70% designed. When fully operational, the solar thermal DHW system should reduce the EUI by an additional 6.6 kBtu/ft<sup>2</sup> (20.8 kWh/m<sup>2</sup>), resulting in an EUI of 33.4 kBtu/ft<sup>2</sup> (105.3 kWh/m<sup>2</sup>), which would be a 75% EUI reduction over pre-renovation performance.

Because metered performance data are preliminary, project conclusions have been based on calculated energy savings from simulation models. Also, full cost breakdowns were not provided for all the ECMs at standard and DER levels, to specify the cost differential between Army requirements (40.1 kBtu/ft<sup>2</sup>) and the calculated EUI predicted to be achieved (26 kBtu/ft<sup>2</sup>/yr). Incremental investment costs for the DER measures have been estimated to be about \$30/ft<sup>2</sup> (\$330/m<sup>2</sup>). Energy tariffs were also not provided in sufficient detail to precisely calculate the avoided costs of the additional energy savings from DER compared to a standard retrofit. Therefore, the predicted and achieved cost effectiveness of the additional DER measures is still to be determined.

Relative to the funding required to support a standard retrofit project, the Army has estimated the DER-specific portions of Bldg. 630's renovation to be less than 10% of overall project costs. This was accomplished in part by an innovative approach to DER efforts that bundles sustainable technologies into overall life cycle cost-effective packages that are demonstrated during pre-award energy modeling and formalized as project requirements and performance targets in the RFP. Recognition also goes to the

organizations responsible for facilitating and implementing this approach, including U.S. Army Garrison Presidio for its initiative, U.S. Army Installation Management Command for its approval and oversight, U.S. Army Corps of Engineers for its technical support, and contractor AECOM for its expertise and partnership.

Execution of these DER acquisition best practices and partial completion of construction have led to the reporting of DER strategies that have worked and others that require fine tuning. As part of the commissioning of the first wing and central plant, stringent testing criteria and system efficiencies are being successfully implemented to maintain the trajectory to meet the 86% energy intensity reduction target and the ultra-low site EUI performance requirement of 18 kBtu/ft<sup>2</sup> (56.73 kWh/m<sup>2</sup>). Subsequent occupation or M&V phases may reveal additional takeaways, but Bldg. 630 already provides Presidio, DoD, and the greater sustainability community with a wealth of documented success and knowledge for how to best approach large DER projects.



Figure D-12. Completed first wing of Presidio Bldg. 630.

## D.15. References

1. A. Zhivov, R. Liesen, R. Lohse, and O. Moerck. 2016. Core Bundles of Technologies to Achieve Deep Energy Retrofit with Major Building Renovation Projects in Europe and North America. *ASHRAE Transactions* 122(1).
2. U.S. Department of Defense (DoD). 2010. DoD 4165.63-M Housing Management Manual, <http://www.dtic.mil/whs/directives/corres/pdf/416563m.pdf>
3. American Society of Heating, Refrigerating, and Air-Conditioning Engineers (ASHRAE). 2009. *ASHRAE Standard 189.1-2009, Standard for the Design of High Performance, Green Buildings Except Low-Rise Residential Buildings*. Atlanta, GA: ASHRAE.
4. Randall Lamb. 2016. Final Air Leakage and Diagnostic Thermography Test Report - Repair Barracks Building 630 – Wing B. Specification 07 05 23, Submittal SD-06. Building Science: Le Mesa, CA.

5. U.S. Energy Independence and Security Act of 2007 (EISA). 2007. (PL) 110-140. Enacted by the 110th US Congress, December 19, 2007.
6. Zhivov, R. Liesen, and P. Ellis. 2012. Energy Renovation Strategies for Army Barracks at the Presidio of Monterey to Meet EPA Act 2005 and EISA 2007 Requirements. Presidio, CA.
7. ASHRAE. 2004. ASHRAE Standard 90.1-2004, Energy Standard for Buildings Except Low-Rise Residential Buildings. Atlanta, GA: ASHRAE.
8. U.S. Department of Energy (DOE). 2011. ENERGY STAR® Performance Ratings Methodology for Incorporating Source Energy Use. Washington, D.C.: U.S. Department of Energy.
9. Headquarters, Department of the Army (HQDA). 2012. Army Regulation AR 420-1 Army Facilities Management. Washington, DC: HQDA.
10. AECOM. 2005. Parametric Cost Engineering System (PACES) software,
11. <https://www.wbdg.org/tools/paces.php?a=1>
12. RSMMeans® Mechanical Cost Data, Norwell, MA: Reed Construction Data, 2013.
13. O. Mørck, L. Rüdiger, M. Sánchez, and A. Zhivov, R, 2016. Deep Energy Retrofit: A Prescriptive Guide to Achieve Significant Energy Use Reduction with Major Renovation Projects Appendix K. Engineer Research and Development Center, Construction Engineering Research Laboratory (ERDC-CERL).



## Appendix E: Federal Building / Courthouse, St. Croix, U.S. Virgin Islands

### Project

Almeric Christian Federal Building/Courthouse, St. Croix, U.S. Virgin Islands.

### Pictures



Figure E-1. Almeric Christian Federal Building and Courthouse.

## E.2. Project summary

### Project objectives

To minimize energy use, maximize RE use, and replace equipment as needed.

### Project energy goals

Achieve at least a 50% reduction in energy use (General Services Administration [GSA] National Deep Energy Retrofit [DER] program objective).

### Short project description:

This project was designed and installed by Schneider Electric as an ESPC under the Department of Energy's (DOE) Federal ESPC contract. The scope was comprehensive and included:

- installation of a ground mounted photovoltaic (PV) system.
- replacement of air handling units (AHUs).
- replacement of the BAS.
- replacement and relocation of the primary transformer.

- installation of window film.
- occupancy-based control of HVAC.

### Stage of construction

Construction is 100% complete and the project has been accepted (September, 2014) by the GSA.

### Point of contact information

GSA: Kevin Bunker Schneider Electric: Kevin Vaughn  
 GSA Region 2 Program Manager Federal ESPC Manager  
 (212) 264-4245 (512) 633-8104  
[Kevin.bunker@gsa.gov](mailto:Kevin.bunker@gsa.gov) kevin.vaughn@schneider-electric.com

### Date of the report

November 17, 2014, updated November 3, 2016.

### Site

Location: Lat 17.75N Long -64.72W  
 Elevation: 85 ft/26m  
 Climate Zone: Zone 1  
 Cooling Degree Days (based on 65 F/18C): 5,818  
 Heating Degree Days (based on 65 F/18C): none

Cooling Design Temperature – 0.4% occurrence*	
Dry Bulb Temp F/C	Mean Coincident Wet Bulb Temp F/C
89.8 F/32 C	77.6 F/25.3 C
Heating Design Temperature – 99.6% occurrence**	
Dry Bulb Temp F/C	N/A
70.3 F/21.3 C	N/A

Building description / typology.

Type: Office/Courthouse.

Age: Constructed 1989.

General information.

Year of construction: 1989.

Year of previous major retrofit: None.

Year of renovation (as described here): 2013 - 2014.

Total floor area: 76,227 ft<sup>2</sup>; 7,082 m<sup>2</sup>.

Area of unconditioned space included above: None.

### Architectural and other relevant drawings

Not available.

### National energy use benchmarks and goals for building type

None applied.

## Site energy tariff information

**Electricity** –\$0.36/kWh for energy.

The current energy tariff is \$ 0.36/kWh, but since all power generation on the island is oil-fired, the electricity tariff is quite volatile, varying with the price of oil. Currently oil prices are low, but during the construction period for this project (2014), the average cost of electricity was over \$ 0.50/kWh. (The reported annual cost for electricity of \$509,777 for 936,000 kWh equates to \$0.545/kWh.) Also, there may be demand charges, customer charges, standby charges, and/or other elements that add to the building's electric energy rate.

## Pre-renovation building details

### Envelope details: walls, roof, windows, insulation levels

8-in. (20cm) CMU walls, tile roof, single-pane windows, R-12 roof insulation.

### Heating, ventilation, cooling and lighting systems

Air-cooled chillers.

Chilled water based variable air volume (VAV) air handling units.

T8 & T12 lighting fixtures.

### Description of the problem: reason for renovation

This building is located on an island where all electricity is generated with oil. This means there are significant rate fluctuations and regular tariff increases. The implementation of a net zero project would significantly reduce both the cost of energy as well as fluctuations in annual cost. Additionally, much of the equipment was at the end of its life and ready for replacement with new, high-efficiency equipment. The advanced ECM implemented as part of a DER will reduce the amount of photovoltaic panels necessary to make the building NZE.

## Energy-saving/process improvement concept and technologies used

### Building envelope improvement

Window Film. The existing double glazing systems use a lightly tinted low-e coating to improve performance. This ECM adds additional highly reflective window tinting film to the existing glazing system to increase the effectiveness of the windows in reflecting direct solar heat gain.

### New HVAC system or retrofits to existing

Chilled Water System Upgrades. Replace three existing 80 ton (281kW) air-cooled chillers with three 60 ton (211kW) air-cooled chillers. In addition, three 5 hp (3.73kW) chilled water distribution pumps and convert to variable volume with variable frequency drives (VFDs).

Replacement of AHUs. Complete replacement of three air handling units with more efficient units.

## **New lighting system**

Lighting Retrofits. Retrofit existing T8 and T12 lamps with LED lamps.

Lighting Controls. Installation of occupancy-based sensors to reduce lighting run hours.

## **New generation/distribution system**

Transformer Replacement. The existing three 333kV main service transformers were oversized and had water-contaminated cooling oil. These units were replaced with three new, appropriate sized units.

## **Renewable energy**

Solar Photovoltaic Array. Install a new ground mounted PV array, approximately 462kW, to generate the power required to take the facility to net zero using a net metering strategy. The necessary automatic transfer switching capability, along with inverters and transformers to interconnect the PV system to the existing facility electrical distribution system, is included.

The predicted annual energy output of the PV array was estimated at 637,722 kWh/year.

## **Building automation system**

### **BAS Upgrades**

1. Upgrade of existing supervisory controls (Network Automation Engine (NAE) and ADX).
2. Enhanced trend logs for real time data analysis and historical archives.
3. Relocation of duct supply air static pressure sensors to proper locations at each air handling unit and provision of secondary sensors for units with two main supply air trunks.
4. Removal of motor starters installed in series with VFDs to ensure equipment longevity.
5. Exposure of all physical points, set-points, time schedules, and modes of operation within the BAS via BACnet/IP to permit integration with the GSA metering platforms, operator workstation, and GSALink analytics platform.
6. Use of Supply Air CO<sub>2</sub> sensors to ensure adequate outdoor air fractions in supply air from VAV air handling units.
7. Reprogramming of existing air handling unit and VAV terminal unit controllers per sequence of operation provided by Schneider Electric.

Occupancy-based VAV Control. Interface of lighting occupancy sensors to local VAV box controllers for real time ventilation scheduling and standby temperature set-point implementation.

## Energy consumption

**Pre-renovation energy use** – 3,286 MBtu/Yr (936,032 kWh/yr) in calendar year 2012. [Note: Annual energy use in 2009 – 2011 was higher by an average of 27%] (Figure E-2 and E-3).

**Predicted energy savings** (site, source, GHG) – 35.7% energy reduction of 1,173 MBtu/Yr (343,772 kWh/yr). 2,176 MBtu (637,722 kWh) is designed to be supplied by the PV array, making the building 3% - 5% better than NZE on an annual basis (Table E-1).

**Annual energy use reduction.** 1,173 MBtu/year (343,772 kWh/year), or 36% of pre-retrofit energy use. 2,176 MBtu (637,722 kWh) is designed to be supplied by the PV array, making the building 3% better than NZE on an annual basis.

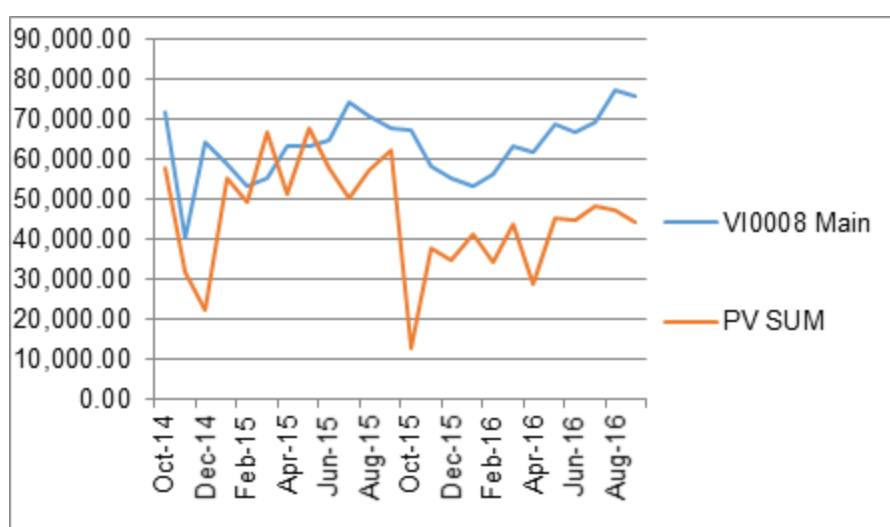

Figure E-2. Monthly building energy use and PV electricity production.

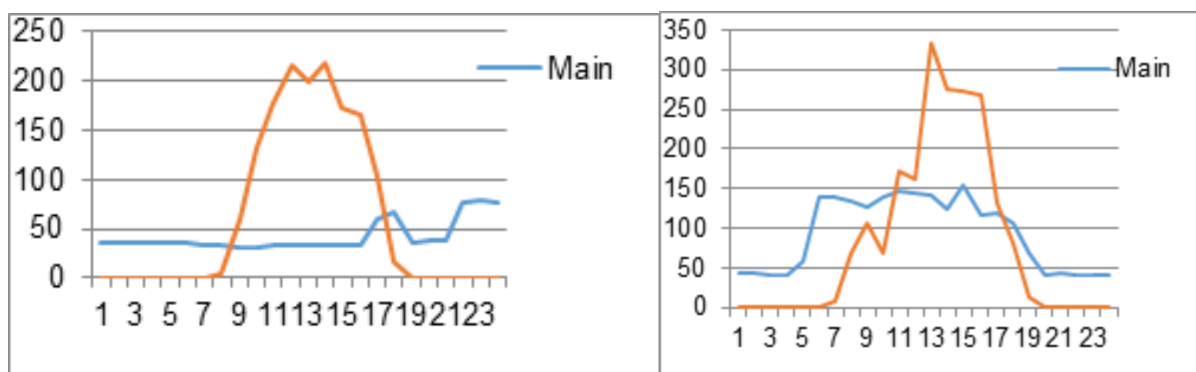

Figure E-3. Example daily load and PV curves.

Table E-1. Measured energy savings.

Annual kWh	Baseline: Pre-retrofit	Designed Retrofit	Actual (kWh/year)			
			FY 2015	FY 2016	Average FY 2015 - 2016	Variance from Design
<b>Building use</b>	936,032	619,259	747,402	772,226	759,814	+ 140,555
<b>PV output</b>	0	637,722	627,892	462,280	545,086	- 92,516
<b>Net from Grid</b>	936,032	- 18,463*	119,509	309,946	214,728	+ 233,191
<b>Variance from Net Zero</b>						+ 214,728
* PV sized to provide about 3% more energy (18,463 kWh) than the building is estimated to use						

### Energy cost reduction (electricity)

The stated objective was to pay nothing to the electric utility, based on a net metering tariff. The avoided costs (in the first year of \$508,076, escalated by 1.4% annually) would be used to pay the ESCO for the cost of the project's implementation and financing. The energy savings are guaranteed, so if the project underperforms (i.e., the building used more energy than the adjusted baseline), the ESCO will be liable to make up the shortfall in savings. Acceptable baseline adjustments include differences in weather (variance from TMY) or occupant-implemented changes in building usage, including times of use/schedule, thermostat settings, number of occupants, types of activities, modifications to structure or equipment, etc.

The stated electricity cost reduction was to be \$509,777/year, including both energy savings and electricity being supplied by the PV system. (It is noted that electric bills from FY2009 to FY2016, as recorded in GSA's Energy Usage Analysis System (EUAS), have never been higher than \$480,000/year.)

The specific terms of the ESPC contract are not reported. The current electricity tariff (\$0.36/kWh) is less than the pre-project tariff (over \$0.50/kWh) due to lower prices for oil. Therefore actual avoided costs will be less than \$500,000. However, ESPC contracts usually have an energy tariff adjustment clause to protect the ESCO from tariff fluctuations beyond its control. (See the National Institute of Standards and Technology's Energy Escalation Rate Calculator at:

<http://energy.gov/eere/femp/building-life-cycle-cost-programs.>)

The post-retrofit building has not been net zero in performance due to outages of some of the PV inverters. It was found that errors in the protection system's settings had exposed the inverters to high transient currents that damaged them. The ESCO has since corrected this.

In FY2015 the building owed the utility \$ 84,036 for electricity; in FY 2016 it owed \$160,693 (Source: GSA EUAS).

### Non-energy-related benefits realized by the project

Since this is designed to be a 100% net zero project, the building is insulated from

fluctuations in the cost of electricity provided by the local utility. These fluctuations can be significant in an island environment where electricity is generated from oil.

The use of on-site PV to supply the majority of the building's electricity has improved its reliability and energy security. During operating hours, the building will still be able to operate even if there is a grid outage.

### Renovation costs

Total: \$6,253,251.

Non-energy-related: \$0.

Energy-related: \$6,253,251.

Table E-2 lists the cost for each measure.

Table E-2. Costs for each measure.

Chilled Water System Upgrades	\$675,877
BAS Upgrades	\$502,902
HVAC Improvements	\$517,771
Lighting Improvements	\$802,949
Window Film	\$39,635
VFDs	\$81,885
Solar PV	\$3,322,147
Transformers	\$291,464
Retro-Commissioning	\$18,621

### Business models and Funding sources

#### Decision-making process criteria for funding and business models

The GSA chose the ESPC funding model (3<sup>rd</sup> party funding) due to funding constraints using appropriated funds. Also, the comprehensive retrofits common with ESPCs would contribute to the GSA's objective of deep energy reductions (>50%).

#### Description of the funding sources chosen

The ESPC funding model is based on 3<sup>rd</sup> party financing that is repaid with energy savings guaranteed by an ESCO.

#### Description of the business model chosen

The business model is based on the ESPC concept where an ESCO:

- Designs an energy efficiency project.
- Develops a plan for M&V of energy savings.
- Arranges 3rd party financing.
- Installs the project.

- Guarantees the energy savings will be sufficient to repay the financing over the finance term, typically 15-20 years.

Appropriated funds of \$118,750 were also used.

### **Risk allocation in the business model**

In an ESPC, most of the performance risk is shifted from the owner to the ESCO. The ESCO is contractually responsible for:

- Designing the project to generate savings.
- Installation of the project to generate savings.
- Maintenance of the project to generate savings during the project term.

### **Funding sources of the business model**

The funding for the project is from a private, 3rd party. The ESCO solicits bids from a minimum of five financiers and chooses the bid with the terms most favorable to the government.

### **Construction phase in the business model**

The ESCO acts as a general contractor for installation of the project and is responsible for meeting all code and environmental requirements. The project must pass a 30-day proof of performance period before the government accepts and takes title to the project.

### **Operation phase**

In an ESPC, the ESCO provides O&M for any equipment installed under the ESPC to ensure that the project delivers the expected savings. The ESCO also uses the M&V Plan to measure the annual energy savings and prepare an annual report. When the savings are less than the contractually guaranteed savings, the ESCO is accountable for the shortfall.

### **Cost effectiveness of energy part of the project**

Some key financial parameters are:

- Construction Period: 11 months.
- Annual Savings: 1<sup>st</sup> year savings – \$508,076, escalated 1.4% annually.
- Project Implementation Cost: \$6,372,000.
- Payback: 19 years plus 13 months construction.
- Simple Payback: 12.5 years.
- Finance Rate: 4.31%.
- Finance Term: 20 years.

### **User evaluation**

#### Description of user training programs within the refurbishment

Training was provided for equipment installed under the ESPC to the users at the end of the construction period. Additionally, O&M manuals were provided and reviewed



with the users. Refresher training will be provided on an annual basis during the 20 year finance term.

#### Integration of user's demands in the planning process

This project was developed with a very collaborative approach. At each step of the planning/development phase, user stakeholder input was provided; there were three points in the development/planning phase where the GSA reviewed and provided comments. Additionally, weekly conference calls were held to review progress and solicit input from the occupants and stakeholders. These calls continued during the construction phase.

### **Experiences/Lessons learned**

#### Energy use

Since this is designed to be a 100% net zero project, the building will be insulated from fluctuations in the cost of electricity provided by the local utility. These fluctuations can be significant in an island environment where electricity is generated from oil.

#### Practical experiences of interest to a broader audience

The use of an ESPC business/funding model allowed rapid implementation of the project. The project development period, from selection of an ESCO to the start of construction, was 10 months. The construction was completed in 11 months.

#### Resulting design guidance

A high level of collaboration was achieved during the development/planning phase resulting in significant user input to the design of the project.

#### Follow up on the renovation

There have been no negative impacts on the occupants due to the renovation.





[www.iea-ebc.org](http://www.iea-ebc.org)



EBC is a programme of the International Energy Agency (IEA)

